



---

**PRODUCT CATALOGUE**

**1. UNIVERSAL SETS AND DRAPES**

- Universal Sets
- Split Sheets
- Patient/Utility Drapes
- Aperture Drapes

**2. SPECIALITY SETS AND DRAPES**

- 3. Angiography Sets and Drapes
- 4. Cardiovascular Sets and Drapes
- 5. ENT/Dental Sets and Drapes
- 6. General/Abdominal Sets and Drapes
- 7. Gynaecology Sets and Drapes
- 8. Neuro Sets and Drapes
- 9. Obstetric Sets and Drapes
- 10. Ophthalmic Sets and Drapes
- 11. Orthopaedic Sets and Drapes
- 12. Urology Sets and Drapes

**13. SUPPLEMENTARIES TO DRAPES**

- Mayo Stand Covers
- Table Covers
- Incise Film
- Pouches
- Equipment Drapes
- Other supplementaries

**14. SURGICAL GOWNS**

**15. SCRUB SUITS/WARM UP JACKETS/CLEAN AIR SUITS**

**16. HEADWEAR**

**17. FACE MASKS**

**18. CLOTHING OTHERS**

**19. X-RAY DETECTABLE SWABS AND SPONGES**

**20. TRAY WRAPS**

EXAMPLE SET

- 996106 1 mayo stand cover 79x145 cm
- 947069 2 adhesive towel 100x100 cm
- 4 cellulose towel 19x25 cm
- 911510 1 op-tape 9x49 cm
- 967772 1 adhesive op-sheet 175x175 cm
- 967782 1 adhesive op-sheet 300x175 cm
- 914080 1 table cover 150x190 cm

699140

5/10

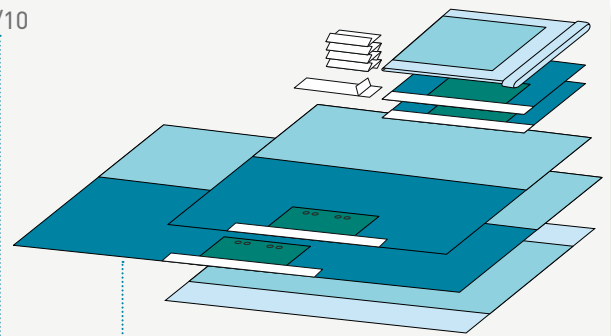

Product illustration

Pieces in Transport Box Sterile

Pieces in Dispenser Box Sterile

Sterile Reference Number

Product Information

Non-sterile Reference Number

Product Name

UNIVERSAL SETS

UNIVERSAL SET STANDARD

699054

6/12

- 996106 1 mayo stand cover 79x145 cm, 65x85 cm absorbent
- 910200 2 adhesive towel 90x75 cm
- 4 cellulose towel 19x25 cm
- 911510 1 op-tape 9x49 cm
- 967772 1 adhesive op-sheet 175x175 cm
- 967773 1 adhesive op-sheet 240x150 cm
- 914080 1 table cover 150x190 cm, 75x190 cm absorbent

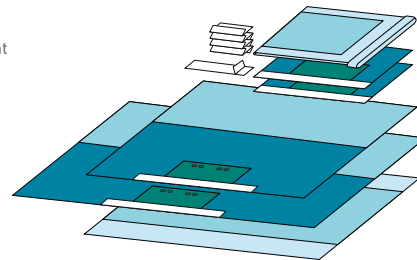

UNIVERSAL SET STANDARD

699140

5/10

- 996106 1 mayo stand cover 79x145 cm, 65x85 cm absorbent
- 947069 2 adhesive towel 100x100 cm
- 4 cellulose towel 19x25 cm
- 911510 1 op-tape 9x49 cm
- 967772 1 adhesive op-sheet 175x175 cm
- 967782 1 adhesive op-sheet 300x175 cm
- 914080 1 table cover 150x190 cm, 75x190 cm absorbent

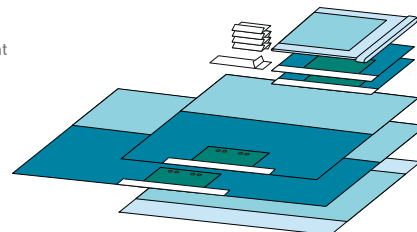

1

2

3

4

5

6

7

8

9

10

11

12

13

14

TABLE COVER

260	9660	140x216 cm, 66x216 cm absorbent, wrapped	20/40	/30
80006263	8106	140x215 cm, 66x216 cm absorbent	20/40	/62
80062601	8045	140x150 cm, 66x150 cm absorbent	30/60	/100
84532021	-	140x140 cm, 66x140 cm absorbent, wrapped	25/50	
84532041	80008022	140x180 cm, 66x180 cm absorbent, wrapped	22/44	/70

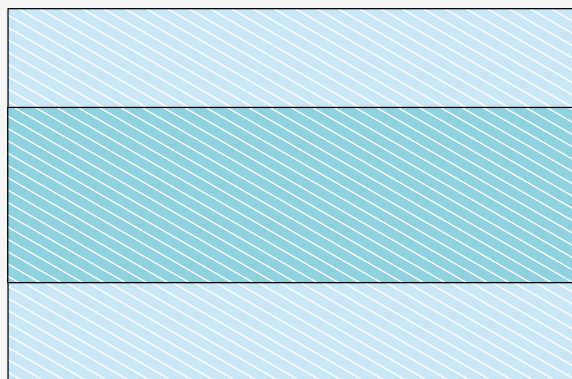

- Product illustration
- Pieces in Transport Box Non-Sterile
- Pieces in Transport Box Sterile
- Pieces in Dispenser Box Sterile
- Product Information
- Non-sterile Reference Number
- Sterile Reference Number

TABLE COVER

TABLE COVER

260	9660	140x216 cm, 66x216 cm absorbent, wrapped	20/40	/30
80006263	8106	140x215 cm, 66x216 cm absorbent	20/40	/62
80062601	8045	140x150 cm, 66x150 cm absorbent	30/60	/100
84532021	-	140x140 cm, 66x140 cm absorbent, wrapped	25/50	
84532041	80008022	140x180 cm, 66x180 cm absorbent, wrapped	22/44	/70

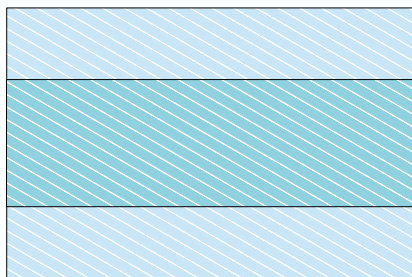
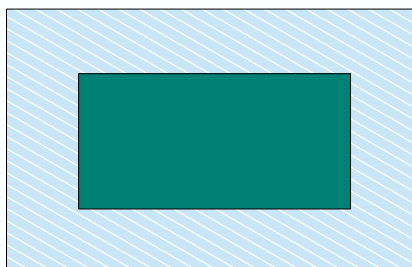

TABLE COVER REINFORCED

264	9376	reinforced 178x280 cm, 91x183 cm absorbent, wrapped	/20	/30
266	930324	reinforced 140x216 cm, 61x152 cm absorbent, wrapped	/22	/30



- 1
- 2
- 3
- 4
- 5
- 6
- 7
- 8
- 9
- 10
- 11
- 12
- 13



BARRIER® is an extensive range of single-use medical devices for use in the operating room, such as surgical drapes, gowns, face masks, headwear, XRD products, scrub clothing and other protective apparel.

All BARRIER products comply with the demands stated in the Medical Device Directive and carry the CE mark, as well as complying with the Quality System Regulations of the US FDA. In these regulations a number of essential requirements are described. The requirements relate to design, production and packaging of the products and contain conditions regarding safety, chemical composition, physical and biological properties and labelling. This assures you that the BARRIER products are safe, fit for use and offer optimum protection.

At Mölnlycke Health Care we are dedicated to creating peace of mind in the operating room. Our BARRIER range is a perfect proof of this.

## THE RIGHT PERFORMANCE IN THE RIGHT PLACE

Bacteria that are spread to the surgical wound from the patient's skin cause a large number of postoperative wound infections. The role of patient drapes is to block this transfer. Our drapes do exactly that job.

Our Universal Set solutions are flexible and can be adjusted to meet most surgical needs. Through our zone draping system BARRIER offers enhanced performance in the critical area through a special reinforcement material that adds strength and fluid control just where it is needed.

The BARRIER Universal Drapes from Mölnlycke Health Care are simply easy-to-use draping alternatives with superior infection control.

	Absorbent And Impermeable Multi Layer Material
	Liquid Repellent Nonwoven Material
	Absorbent And Impermeable Reinforcement/Instrument Pad
	Impermeable 2 ply Material
	Impermeable 2 ply Material
	Impermeable 1 ply Material
	Impermeable 1 ply Material
	Incise Film
	Elastic Film
	Clear Plastic Film



## UNIVERSAL SETS AND DRAPES



UNIVERSAL SET BASIC

698740

7/14

- 4 cellulose towel 19x25 cm
- 910598 2 adhesive towel 75x75 cm
- 911510 1 op-tape 9x49 cm
- 967774 2 adhesive op-sheet 175x150 cm
- 914080 1 table cover 150x190 cm, 75x190 cm absorbent

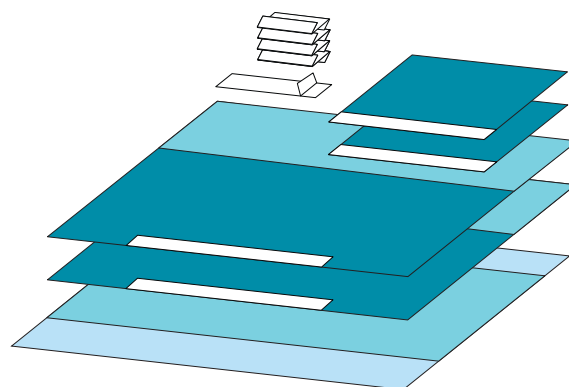

UNIVERSAL SET BASIC

698900

6/12

- 996106 1 mayo stand cover 79x145 cm, 65x85 cm absorbent
- 4 cellulose towel 19x25 cm
- 911510 1 op-tape 9x49 cm
- 930200 2 adhesive towel 90x75 cm
- 967775 1 adhesive op-sheet 175x175 cm
- 967776 1 adhesive op-sheet 240x150 cm
- 914080 1 table cover 150x190 cm, 75x190 cm absorbent

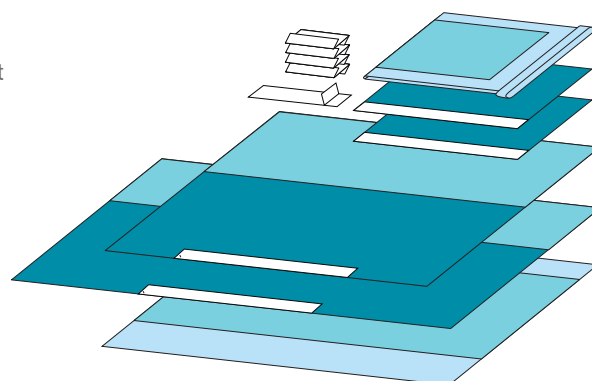

PAEDIATRIC SET BASIC

699010

6/12

- 996106 1 mayo stand cover 79x145 cm, 65x85 cm absorbent
- 4 cellulose towel 19x25 cm
- 917198 2 adhesive towel 75x75 cm, adhesive 2,5cm
- 911510 1 op-tape 9x49 cm
- 917775 1 adhesive op-sheet 175x173 cm, adhesive 2,5cm
- 917776 1 adhesive op-sheet 240x148 cm, adhesive 2,5cm
- 914080 1 table cover 150x190 cm, 75x190 cm absorbent

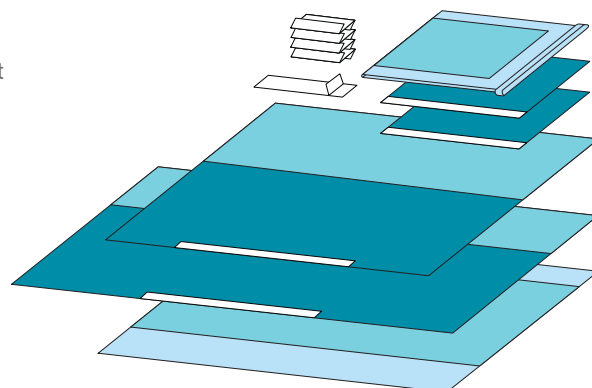

UNIVERSAL SET BASIC

699145

5/10

- 996106 1 mayo stand cover 79x145 cm, 65x85 cm absorbent
- 927069 2 adhesive towel 100x100 cm
- 4 cellulose towel 19x25 cm
- 911510 1 op-tape 9x49 cm
- 967775 1 adhesive op-sheet 175x175 cm
- 967882 1 adhesive op-sheet 300x175 cm
- 914080 1 table cover 150x190 cm, 75x190 cm absorbent

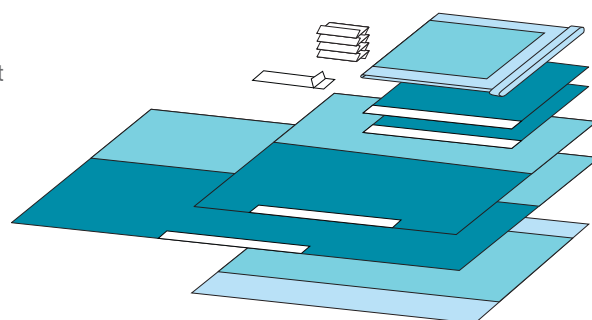

UNIVERSAL SET BASIC

904194

12/24

- 2 cellulose towel 19x25 cm
- 930200 4 adhesive towel 90x75 cm
- 914080 1 table cover 150x190 cm, 75x190 cm absorbent

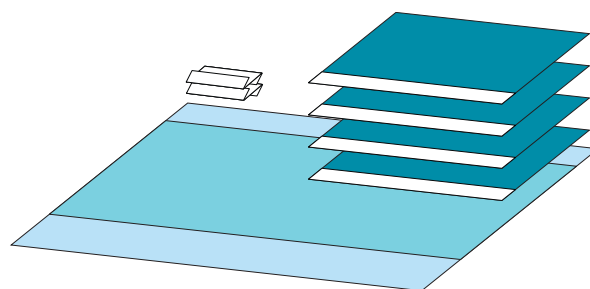

UNIVERSAL SET STANDARD

698780

6/12

- 4 cellulose towel 19x25 cm
- 910200 2 adhesive towel 90x75 cm
- 911510 1 op-tape 9x49 cm
- 967772 1 adhesive op-sheet 175x175 cm
- 967773 1 adhesive op-sheet 240x150 cm
- 948090 1 table cover reinforced 150x190 cm, 65x190 cm absorbent
- 1 wrap 100x100 cm

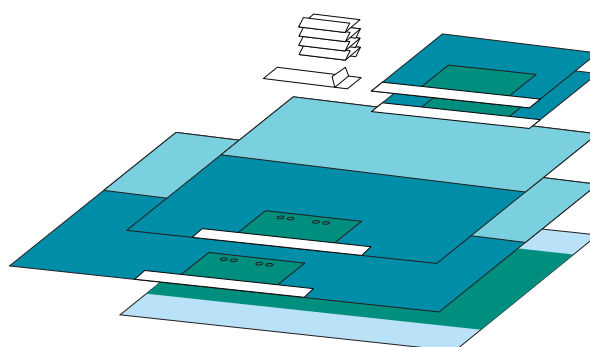

UNIVERSAL SET STANDARD

699054

6/12

- 996106 1 mayo stand cover 79x145 cm, 65x85 cm absorbent
- 910200 2 adhesive towel 90x75 cm
- 4 cellulose towel 19x25 cm
- 911510 1 op-tape 9x49 cm
- 967772 1 adhesive op-sheet 175x175 cm
- 967773 1 adhesive op-sheet 240x150 cm
- 914080 1 table cover 150x190 cm, 75x190 cm absorbent

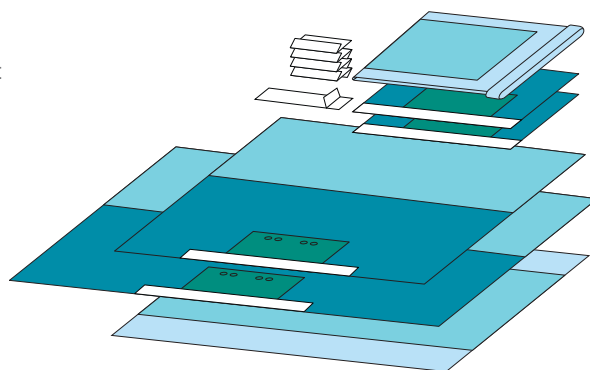

UNIVERSAL SET STANDARD

699140

5/10

- 996106 1 mayo stand cover 79x145 cm, 65x85 cm absorbent
- 947069 2 adhesive towel 100x100 cm
- 4 cellulose towel 19x25 cm
- 911510 1 op-tape 9x49 cm
- 967772 1 adhesive op-sheet 175x175 cm
- 967782 1 adhesive op-sheet 300x175 cm
- 914080 1 table cover 150x190 cm, 75x190 cm absorbent

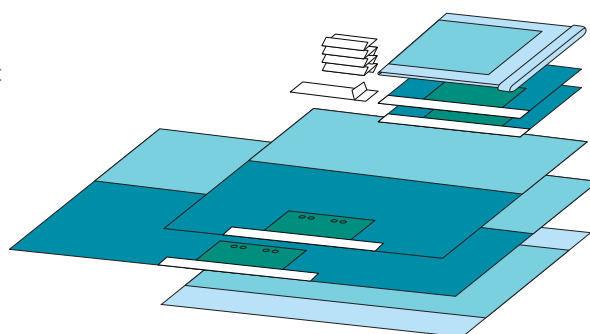

UNIVERSAL SET STANDARD

699340

7/14

- 910200 2 adhesive towel 90x75 cm
- 4 cellulose towel 19x25 cm
- 911510 1 op-tape 9x49 cm
- 967772 1 adhesive op-sheet 175x175 cm
- 967773 1 adhesive op-sheet 240x150 cm
- 914080 1 table cover 150x190 cm, 75x190 cm absorbent

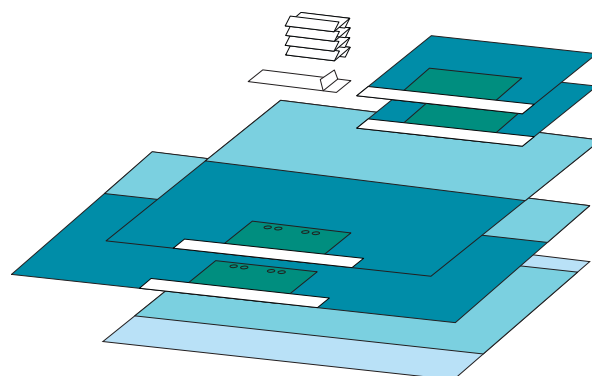

UNIVERSAL SET STANDARD

699354

6/12

- 947069 2 adhesive towel 100x100 cm
- 4 cellulose towel 19x25 cm
- 911510 1 op-tape 9x49 cm
- 967772 1 adhesive op-sheet 175x175 cm
- 967773 1 adhesive op-sheet 240x150 cm
- 914080 1 table cover 150x190 cm, 75x190 cm absorbent

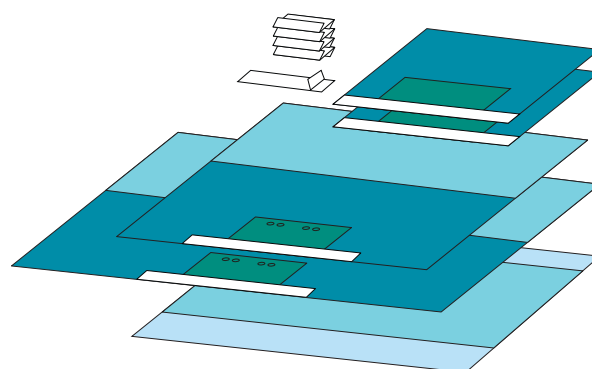

UNIVERSAL SET STANDARD

699600

4/8

- 750105 1 surgical gown LL + 2 hand towel 45 x 33 cm, wrapped
- 996106 1 mayo stand cover 79x145 cm, 65x85 cm absorbent
- 4 cellulose towel 19x25 cm
- 910200 2 adhesive towel 90x75 cm
- 750115 1 surgical gown XLL + 2 hand towel 45 x 33 cm, wrapped
- 911510 1 op-tape 9x49 cm
- 967772 1 adhesive op-sheet 175x175 cm
- 967773 1 adhesive op-sheet 240x150 cm
- 914080 1 table cover 150x190 cm, 75x190 cm absorbent

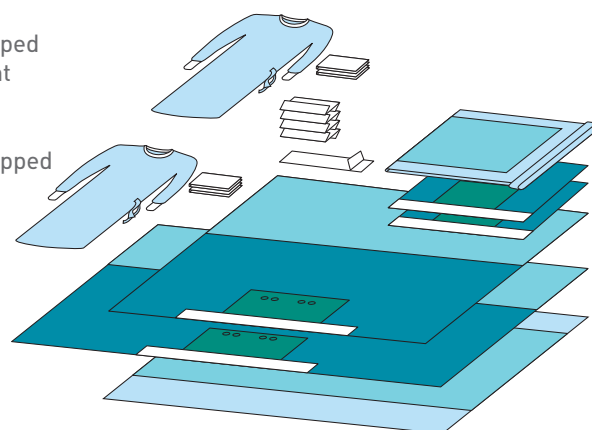

UNIVERSAL SET STANDARD

699640

6/12

- 996106 1 mayo stand cover 79x145 cm, 65x85 cm absorbent
- 910519 1 op-towel 75x90 cm
- 4 cellulose towel 19x25 cm
- 910198 2 adhesive towel 75x75 cm
- 911510 1 op-tape 9x49 cm
- 967772 1 adhesive op-sheet 175x175 cm
- 967773 1 adhesive op-sheet 240x150 cm
- 914080 1 table cover 150x190 cm, 75x190 cm absorbent

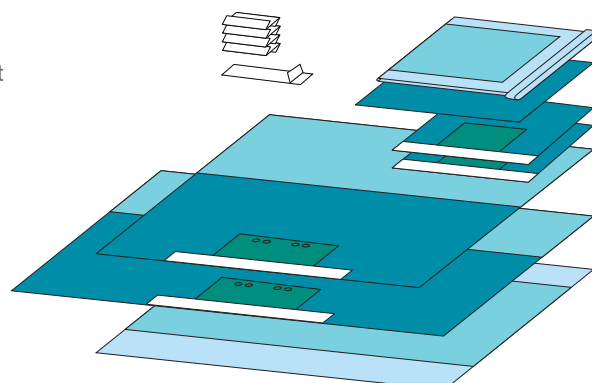

UNIVERSAL SET STANDARD

699700

4/8

- 750105 1 surgical gown LL + 2 hand towel 45 x 33 cm, wrapped
- 996106 1 mayo stand cover 79x145 cm, 65x85 cm absorbent
- 4 cellulose towel 19x25 cm
- 910200 2 adhesive towel 90x75 cm
- 750105 1 surgical gown LL + 2 hand towel 45 x 33 cm, wrapped
- 9115101 1op-tape 9x49 cm
- 967772 1 adhesive op-sheet 175x175 cm
- 967773 1 adhesive op-sheet 240x150 cm
- 914080 1 table cover 150x190 cm, 75x190 cm absorbent

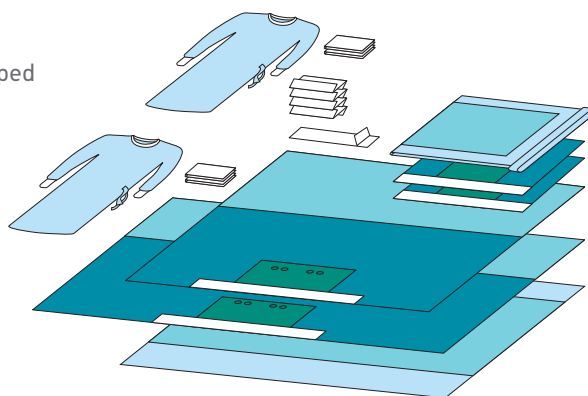

UNIVERSAL SET STANDARD

699800

3/6

- 3 hand towel 30x70 cm
- 750102 1 surgical gown L
- 4 cellulose towel 19x25 cm
- 750103 2 surgical gown LL
- 911510 1 op-tape 9x49 cm
- 914079 1 table cover 100x150 cm, 75x150 cm absorbent
- 914080 1 table cover 150x190 cm, 75x190 cm absorbent
- 910198 4 adhesive towel 75x75 cm
- 967772 1 adhesive op-sheet 175x175 cm
- 967773 1 adhesive op-sheet 240x150 cm
- 914080 1 table cover 150x190 cm, 75x190 cm absorbent

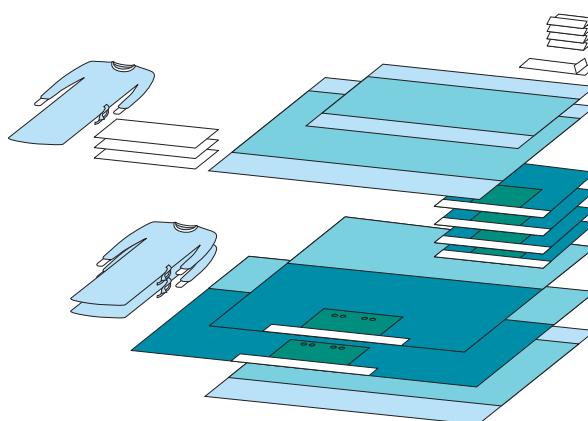

UNIVERSAL SET SPECIAL

699175

5/10

- 4 cellulose towel 19x25 cm
- 911510 2 op-tape 9x49 cm
- 917069 2 adhesive towel reinforced 100x100 cm
- 937771 1 adhesive op-sheet reinforced 240x175 cm
- 937782 1 adhesive op-sheet reinforced 300x175 cm
- 948090 1 table cover reinforced 150x190 cm, 65x190 cm absorbent
- 1 wrap 100x100 cm

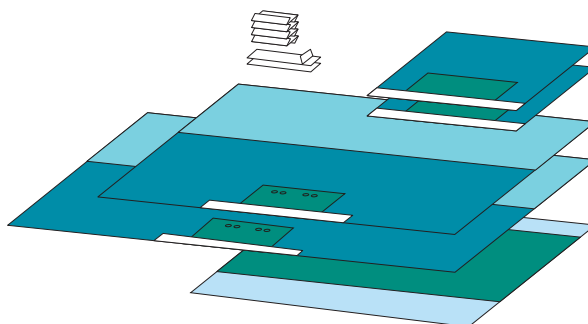

UNIVERSAL SET SPECIAL

699180

5/10

- 996109 1 mayo stand cover reinforced 79x145 cm, 65x85 cm absorbent
- 917069 2 adhesive towel reinforced 100x100 cm
- 4 cellulose towel 19x25 cm
- 911510 2 op-tape 9x49 cm
- 937771 1 adhesive op-sheet reinforced 240x175 cm
- 937782 1 adhesive op-sheet reinforced 300x175 cm
- 948090 1 table cover reinforced 150x190 cm, 65x190 cm absorbent

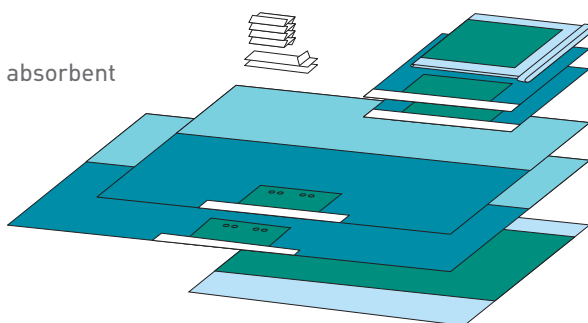

SET-UP SET

282

/35

- 1 suture bag 16.5x28.5 cm
- 9544 1 mayo stand cover 58x137 cm, 45x56 cm absorbent
- 9660 1 table cover 140x216 cm, 66x216 cm absorbent

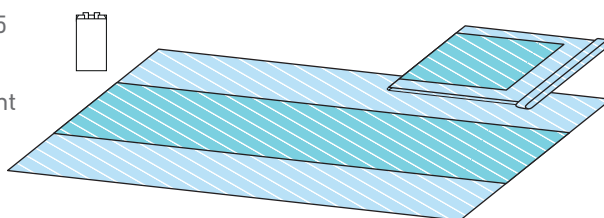

SET-UP SET

1268

/7

- 9544 1 mayo stand cover 58x137 cm, 46x56 cm absorbent
- 1 suture bag 16.5x28.5 cm
- 9569 1 adhesive patient drape 196x188 cm, reinforcement 46x71 cm
- 9969 1 adhesive patient drape 254x183 cm, reinforcement 30.5x71 cm
- 9869 2 adhesive towel 196x91 cm, reinforcement 150x31 cm
- 930324 1 table cover reinforced 140x216 cm, 61x152 cm absorbent

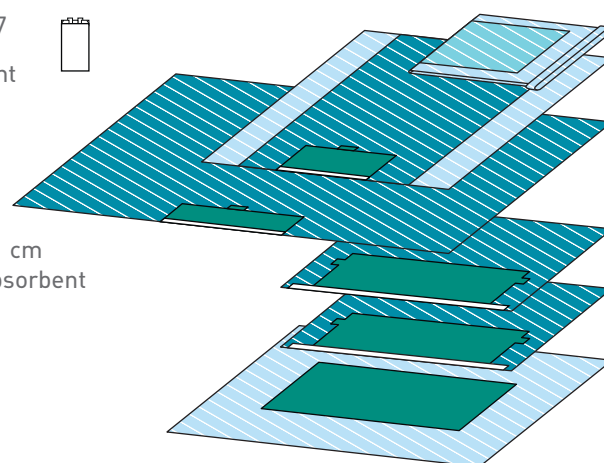

SET-UP SET

8584691

/36

- 8046 1 mayo stand cover reinforced 79x145 cm, 65x85 cm absorbent
- 8045 1 table cover 140x150 cm, 66x150 cm absorbent
- 1 wrap 61x61 cm

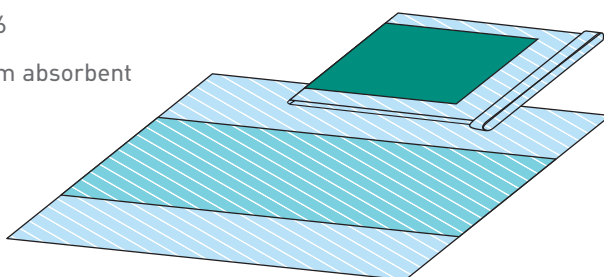

UNIVERSAL SET

80005166

/8

- 2 cellulose towel 50x50 cm
- 8046 1 mayo stand cover reinforced 79x145 cm, 61x85 cm absorbent
- 920504 1 adhesive patient drape 183x190 cm, reinforcement 30x80 cm
- 8008075 2 adhesive utility drape 115x92 cm, reinforcement 30x90 cm
- 2 op-tape 8x45 cm
- 1 adhesive patient drape 146x300 cm, reinforcement 92x90 cm
- 930324 1 table cover reinforced 140x215 cm, 61x152 cm absorbent

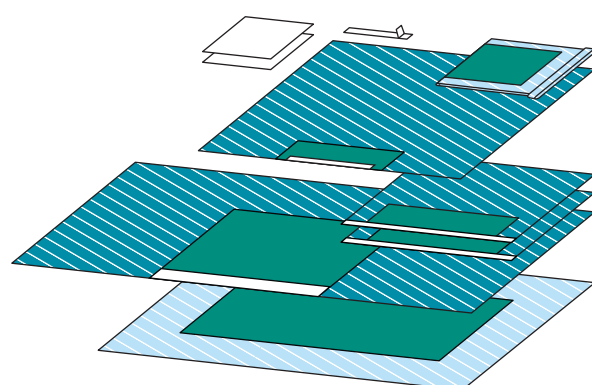

**UNIVERSAL SET ABSORBENT**

80011652

/12

- 8014 2 adhesive utility drape 90x75 cm
- 9911 2 adhesive patient drape 173x185 cm
- 1 wrap 86x86 cm

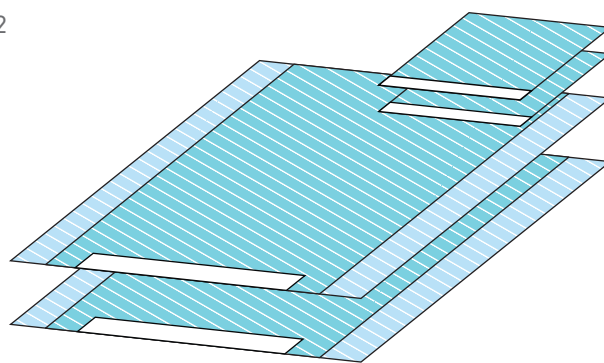

**REINFORCED UNIVERSAL SET**

80575032

/4

- 8046 1 mayo stand cover reinforced 79x145 cm, 61x85 cm absorbent
- 1 adhesive op-sheet 180x180 cm, reinforcement 30x80 cm
- 8008052 1 adhesive op-sheet 254x183 cm, reinforcement 30x80 cm
- 80008048 2 adhesive utility drape reinforced 91,5x75 cm
- 8081 1 op-tape 9x50 cm
- 9660 1 table cover 140x215 cm, 66x215 cm absorbent

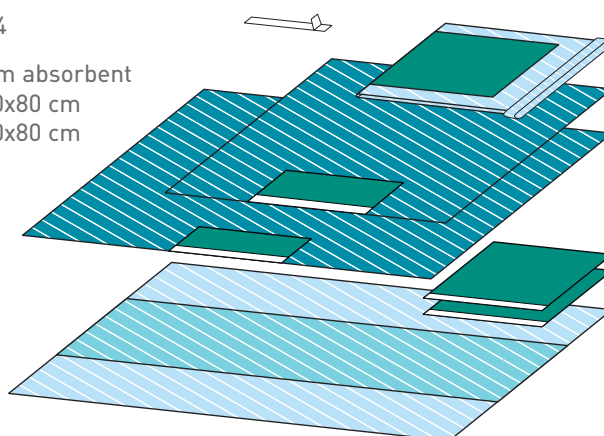

**REINFORCED UNIVERSAL SET**

80974502

/7

- 9915 2 adhesive utility drape 115x92 cm, reinforcement 30x90 cm
- 2 adhesive patient drape 180x180 cm, reinforcement 30x80 cm
- 9660 1 table cover 140x216 cm, 66x216 cm absorbentm

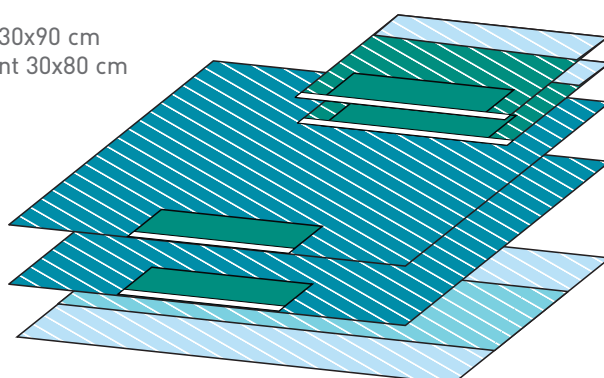

**SIDE DRAPE SET**

84511060

/30

- 8014 4 adhesive utility drape 90x75 cm
- 1 table cover 140x160 cm, 66x160 cm absorbent

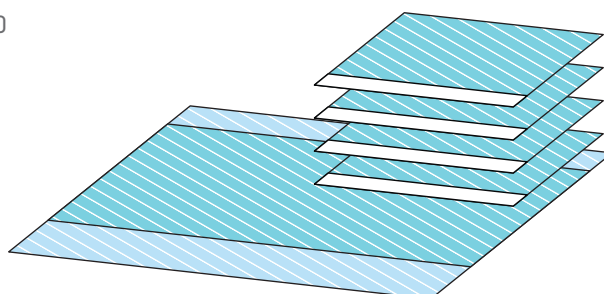

**REINFORCED UNIVERSAL SET**

**84511092**

/8

- 2 cellulose towel 50x50 cm
- 2 op-tape 8x45 cm
- 9915 2 adhesive utility drape 115x92 cm, reinforcement 30x90 cm
- 1 adhesive patient drape 254x183 cm, reinforcement 30x80 cm
- 1 adhesive patient drape 254x183 cm, reinforcement 30x80 cm
- 9660 1 table cover 140x216 cm, 66x216 cm absorbent

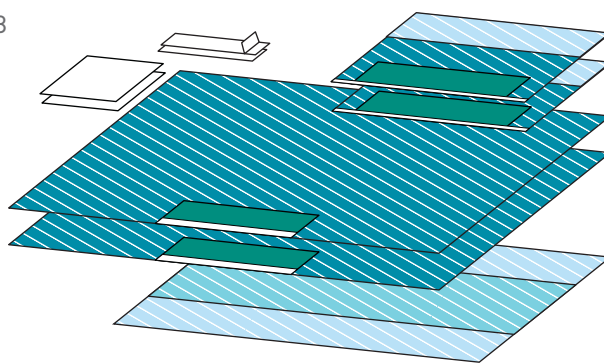

**REINFORCED UNIVERSAL SET**

**84511472**

/7

- 2 cellulose towel 50x50 cm
- 1 op-tape 8x45 cm
- 9915 2 adhesive utility drape 115x92 cm, reinforcement 30x90 cm
- 9913 1 adhesive patient drape 201x201 cm, reinforcement 30x80 cm
- 1 adhesive patient drape 254x183 cm, reinforcement 30x80 cm
- 9660 1 table cover 140x216 cm, 66x216 cm absorbent

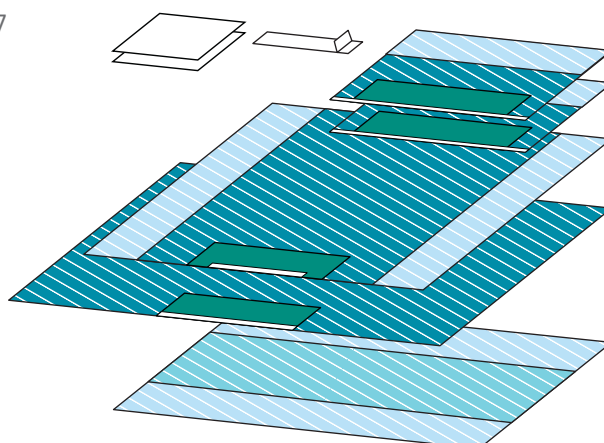

**UNIVERSAL SET**

**84512012**

/14

- 2 cellulose towel 50x50 cm
- 8014 2 adhesive utility drape 90x75 cm
- 1 op-tape 8x45 cm
- 9909 1 adhesive patient drape 240x150 cm
- 9911 1 adhesive patient drape 173x185 cm
- 9660 1 table cover 140x216 cm, 66x216 cm absorbent

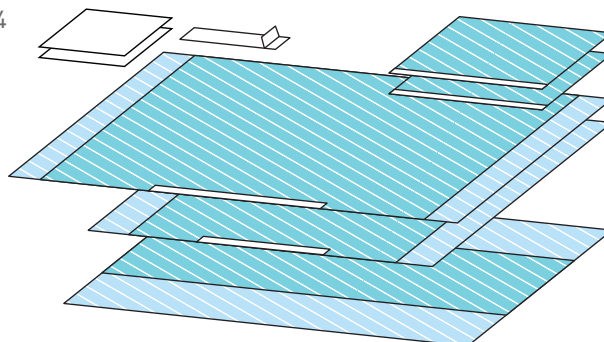

**REINFORCED UNIVERSAL SET**

**84512031**

/7

- 2 op-tape 8x45 cm
- 2 cellulose towel 50x50 cm
- 8046 1 mayo stand cover reinforced 79x145 cm, 61x85 cm absorbent
- 1 adhesive split sheet, 196x290 cm, split 23x76 cm, reinforcement 46x91 cm
- 1 adhesive patient drape 250x168 cm, reinforcement 30x80 cm
- 9660 1 table cover 140x216 cm, 66x216 cm absorbent

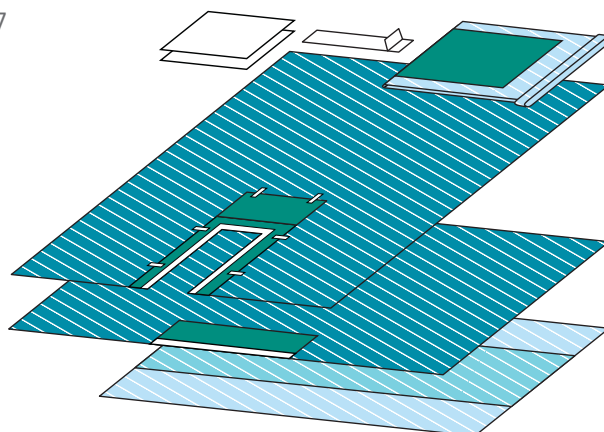

ADHESIVE SPLIT SHEET

778900

15/60

980789 150x125 cm, split 7x45 cm

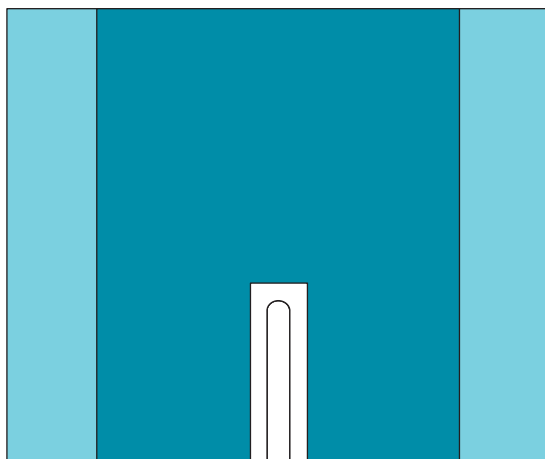

ADHESIVE SPLIT SHEET

779300

13/26

980793 200x260 cm, split 7x102 cm

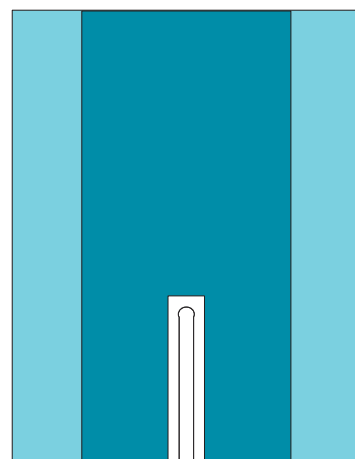

ADHESIVE SPLIT SHEET

<b>779000</b>	980790	200x150 cm, split 7x65 cm, patch 50x100 cm	9/36
<b>779400</b>	980794	200x260 cm, split 7x102 cm, patch 50x100 cm	12/24
<b>910620</b>	980796	150x260 cm, split 7x65 cm, patch 50x50 cm	14/28
<b>920249</b>	950798	200x260 cm, split 20x102 cm, patch 50x100 cm	12/24

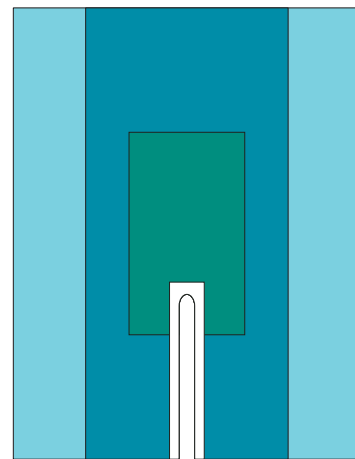



**ADHESIVE SPLIT SHEET**

**206** /21

9203 146x196 cm, reinforcement 46x122 cm, split 6x79 cm, wrapped /30

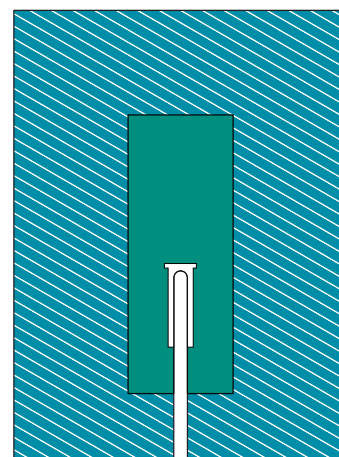

**SPLIT SHEET**

**1298** /13

9598 208x295 cm, reinforcement 46x122 cm, split 10x119 cm, wrapped /15

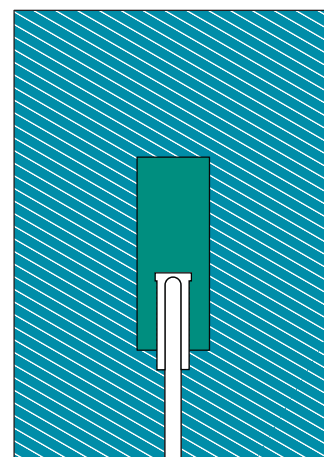

**ADHESIVE SPLIT SHEET**

**2750** /36

9475 152x193 cm plastic, split 15x61 cm, wrapped /55

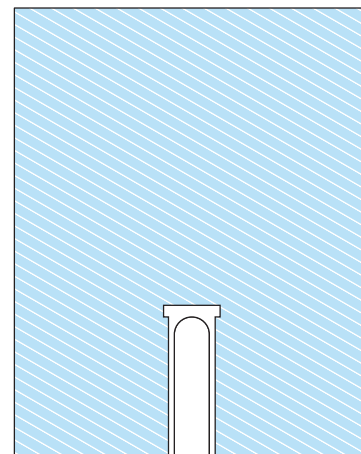

**PREP PAD**

**80006214** /50

9214 61x112 cm, split 10x36 cm, wrapped /130

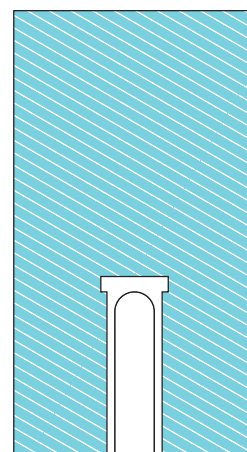

**ADHESIVE SPLIT SHEET**

**80057500** /8

80008020 208x254 cm, reinforcement 91x90 cm, split 10x37 + 53 cm, wrapped /150

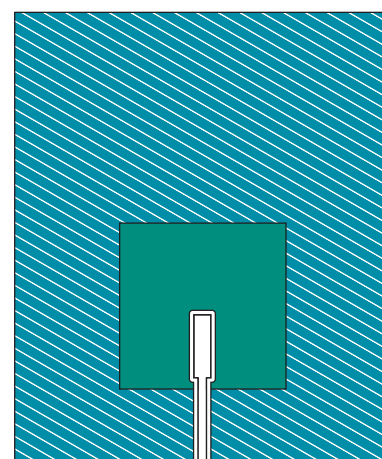

**ADHESIVE SPLIT SHEET**

**84522072** /14

920420 254x257 cm, reinforcement 91x90 cm, split 10x37 cm + 53cm, wrapped /19

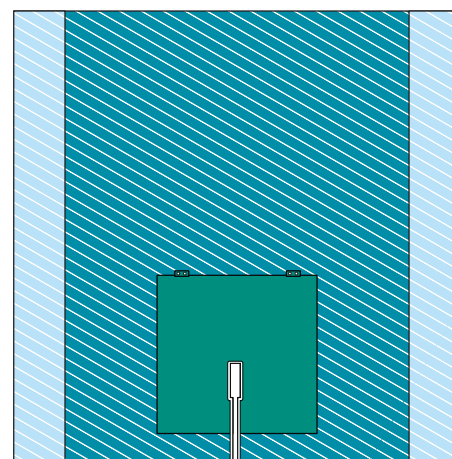

**ADHESIVE OP-SHEET**

<b>777400</b>	967774	175x150 cm	15/30
<b>777525</b>	917775	175x173 cm, paediatric	13/26
<b>777600</b>	967776	240x150 cm	12/24
<b>778200</b>	967882	300x175 cm	8/16
<b>920496</b>	967775	175x175 cm	13/26

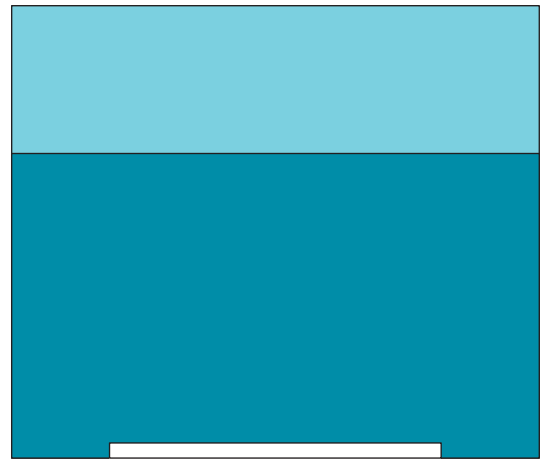

**ADHESIVE TOWEL**

<b>706300</b>	947063	75x75 cm	40/240
<b>706400</b>	947064	50x50 cm	50/300
<b>706500</b>	910598	75x75 cm	28/168
<b>706525</b>	917198	75x75 cm, paediatric	28/168
<b>706700</b>	947067	75x100 cm	20/120
<b>706900</b>	927069	100x100 cm	40/80
<b>707500</b>	910598	2 pcs 75x75 cm	30/180
<b>904664</b>	927069	2 pcs 100x100 cm	44/88
<b>906677</b>	930200	90x75 cm	28/168

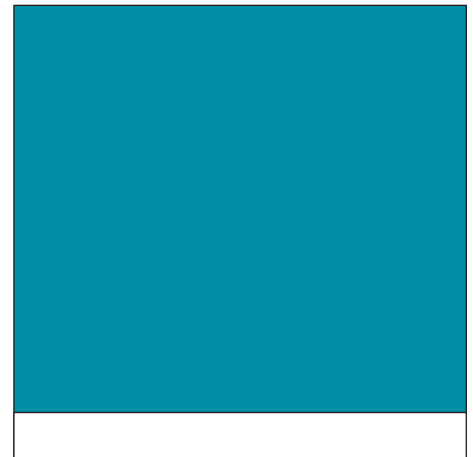

**ADHESIVE TOWEL**

	<b>706800</b>	42/84
910200	90x75 cm, patched	

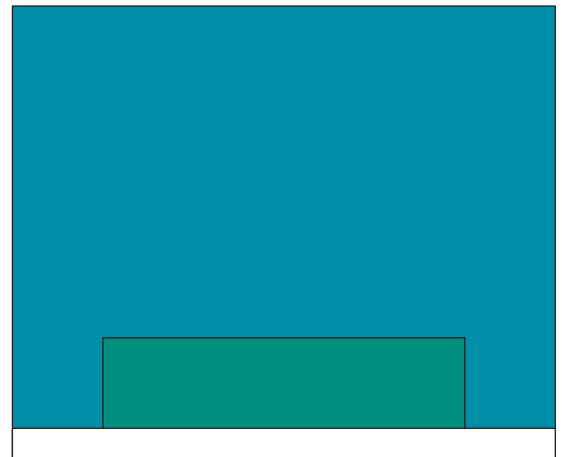

**ADHESIVE TOWEL**

	<b>706100</b>	25/50
904764	absorbent pad 55x70 cm	

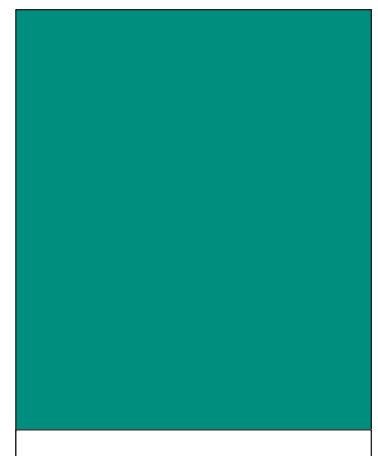

OP SHEET

<b>777900</b>	910184	90x150 cm	28/56
<b>778000</b>	910185	150x175 cm	14/28
<b>778100</b>	910186	150x240 cm	11/22

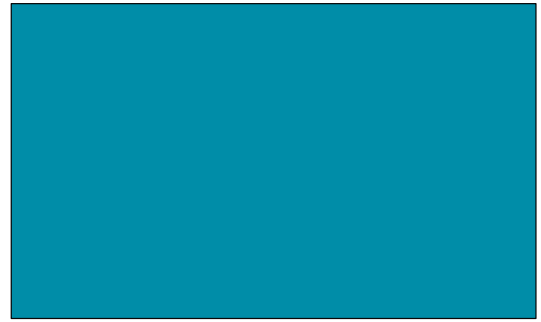

PERINEAL DRAPE

**706200** 23/138

967062 75x120 cm, 8x12 cm + utility drape 75x90 cm

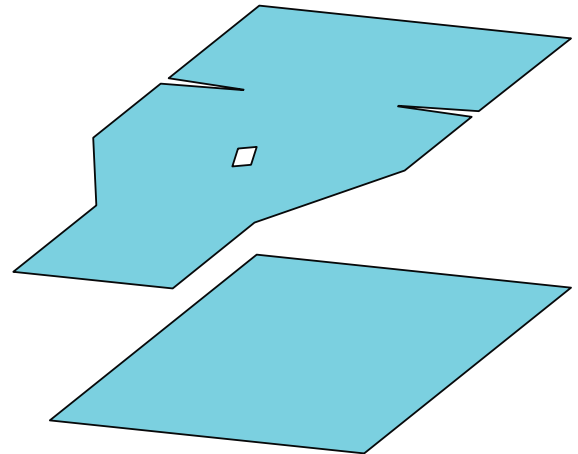

UNDER BUTTOCKS DRAPE

**828900** 40/80

972890 75x100 cm

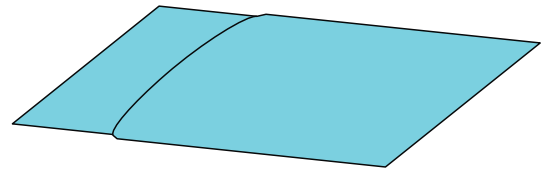

UTILITY DRAPE

<b>700330</b>	-	3-ply 37,5x45 cm	120/480
<b>700430</b>	904759	3-ply 45x75 cm	80/320
<b>700530</b>	947005	3-ply 75x90 cm	30/180
<b>800330</b>	968003	2-ply 37,5x45 cm	160/640
<b>800430</b>	968004	2-ply 45x75 cm	100/400
<b>800530</b>	968005	2-ply 75x90 cm	40/240
<b>906834</b>	904713	2-ply 50x60 cm	120/480

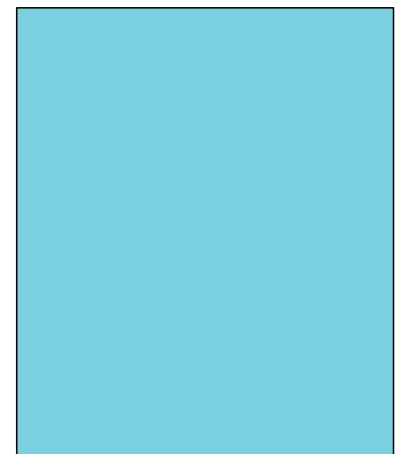

**UNDER BUTTOCKS DRAPE w/ POUCH**

**229**

/33

9229 86x112cm, pad 46x30 cm, wrapped

/40

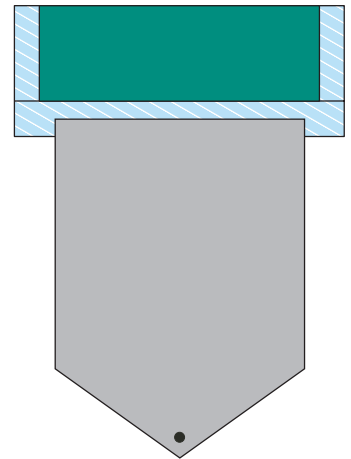

**UNDER BUTTOCKS DRAPE**

**1229**

/54

9629 91x117 cm, 45x56 cm absorbent, wrapped

/60

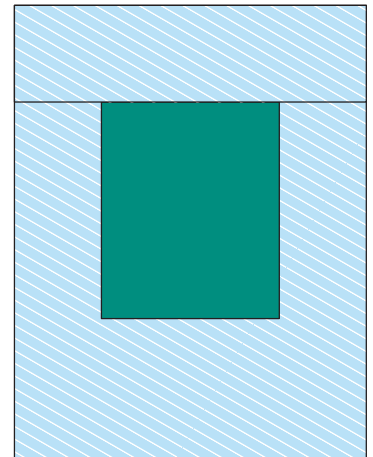

**PATIENT DRAPE**

**1289**

/24

9689 146x196 cm, reinforcement 61x119 cm, wrapped

/36

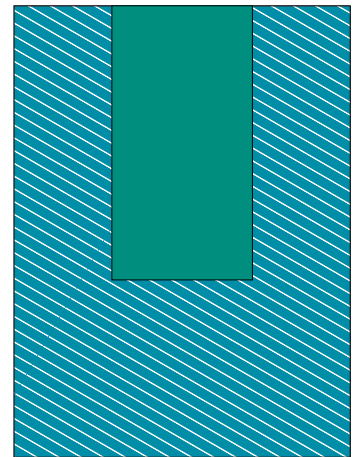

**ADHESIVE UTILITY DRAPE**

**80452108**

/60

8008075 115x92 cm, reinforcement 30x92 cm, wrapped

/70

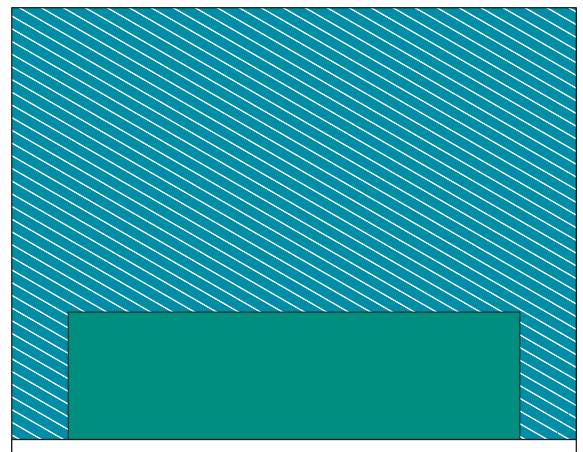

UTILITY DRAPE

<b>80647590</b>	8036	75x90 cm	50/300	/240
<b>80649015</b>	8018	90x150 cm	25/150	/108
<b>86445750</b>	-	45x75 cm	60/360	-

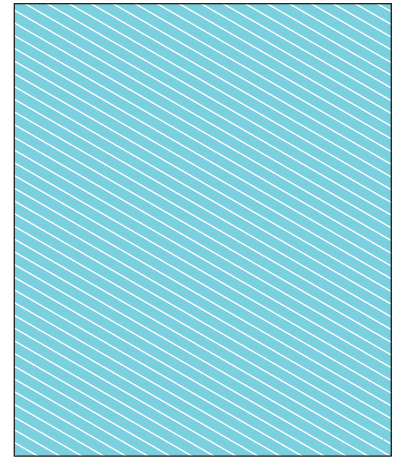

ADHESIVE UTILITY DRAPE

<b>80657590</b>	8014	90x75 cm	40/240	/240
<b>84521041</b>	922309	50x30 cm, 4 pcs, wrapped	/240	/350

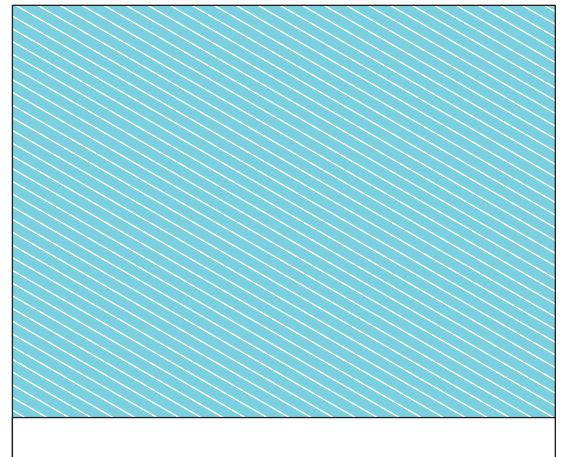

ADHESIVE PATIENT DRAPE

			<b>84521231</b>	/25
8008052	254x183 cm, reinforcement 30x80 cm, wrapped			/24

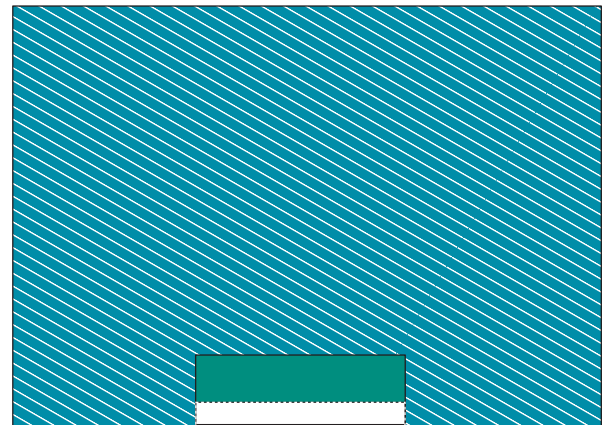

ADHESIVE APERTURE DRAPE

706610

20/120

956601 100x125 cm, 11 cm

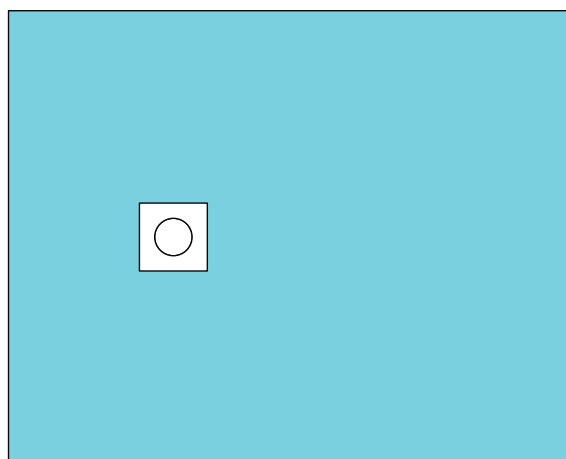

ADHESIVE APERTURE DRAPE

706620

970662 variable 50x75 cm

40/240

706630

970663 variable 75x100 cm

30/180

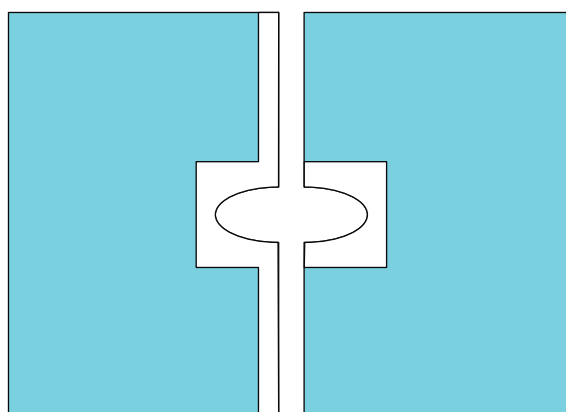

ADHESIVE APERTURE DRAPE

708840

32/64

968840 120x150 cm, 5x7 cm

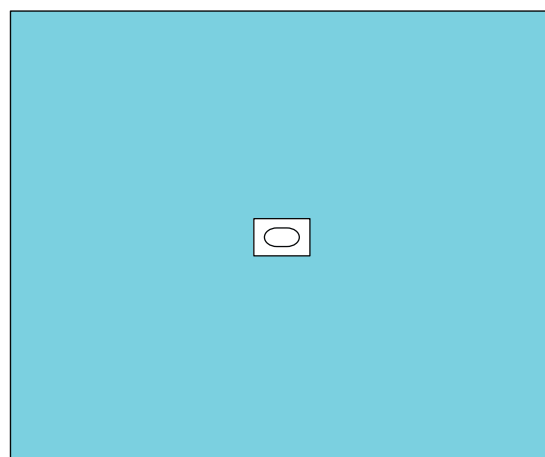

ADHESIVE APERTURE DRAPE

708850

20/40

968850 150x180 cm, 5x15 cm

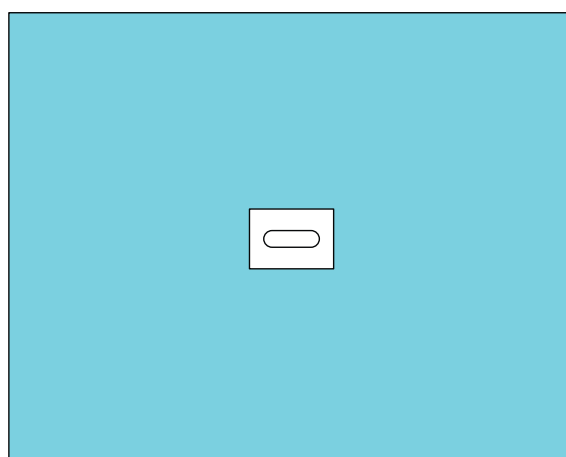

---

**ADHESIVE APERTURE DRAPE**

**708860**

17/34

968860 200x240 cm, 12 cm

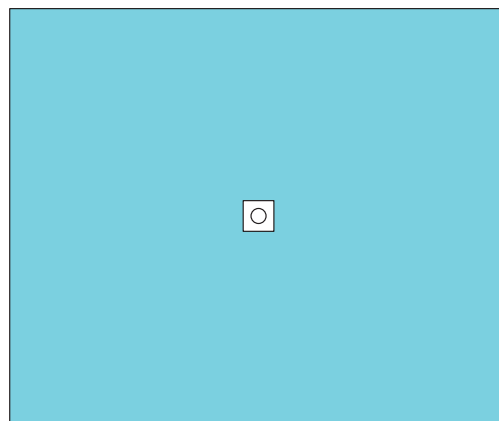

---

**ADHESIVE APERTURE DRAPE**

**708870**

12/24

968870 200x280 cm, 15 cm, 100 cm from top

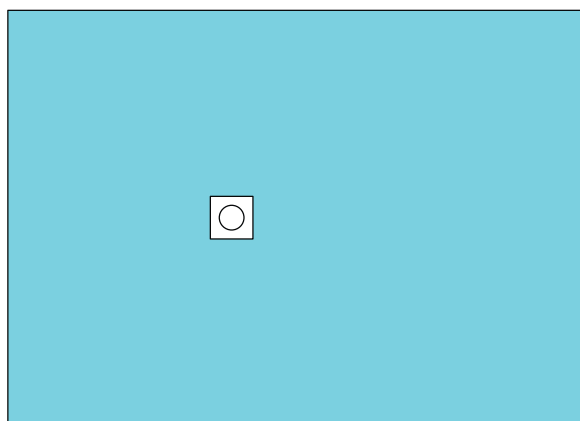

---

**ADHESIVE APERTURE DRAPE**

**708880**

14/28

968880 200x280 cm, 14x14 cm, 124 cm from top

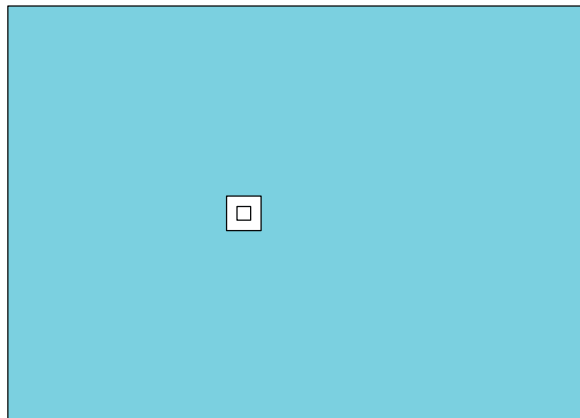



ADHESIVE APERTURE DRAPE

904622

140/560

- 45x75 cm, 7 cm

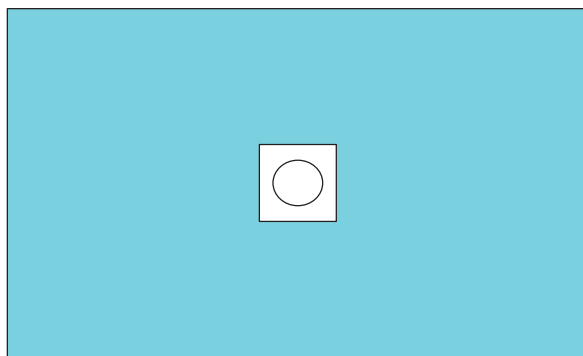

ADHESIVE APERTURE DRAPE

904624

80/320

- 75x90 cm, 7 cm

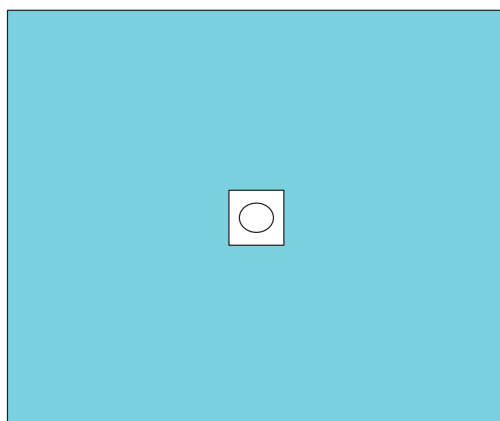

ADHESIVE APERTURE DRAPE

906540

50/300

904741 60x75 cm, 6x9.5 cm

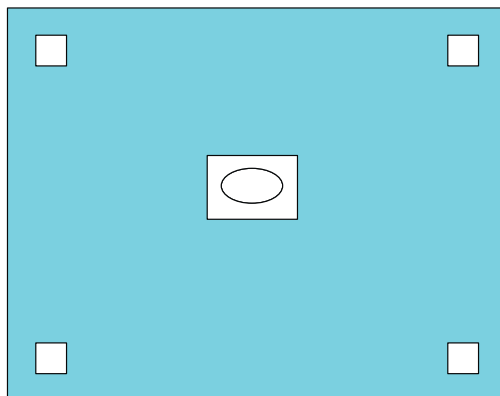

ADHESIVE APERTURE DRAPE

906542

40/160

904758 75x90 cm, 6x8 cm

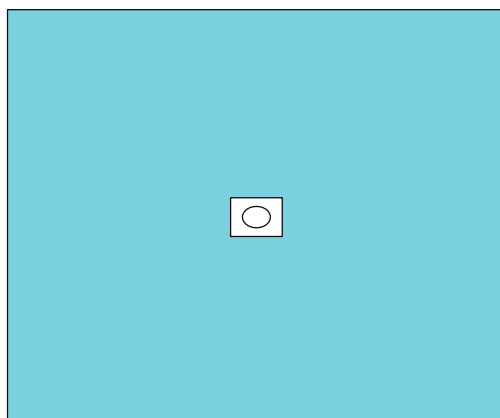

ADHESIVE APERTURE DRAPE

906544

75/300

904736 50x60 cm, 6x8 cm

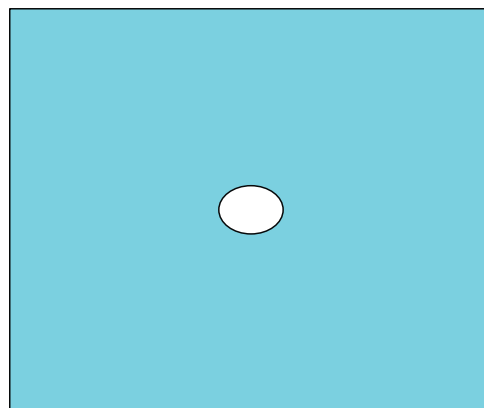

ADHESIVE APERTURE DRAPE

906693

75/300

904737 50x60 cm, 6x8 cm

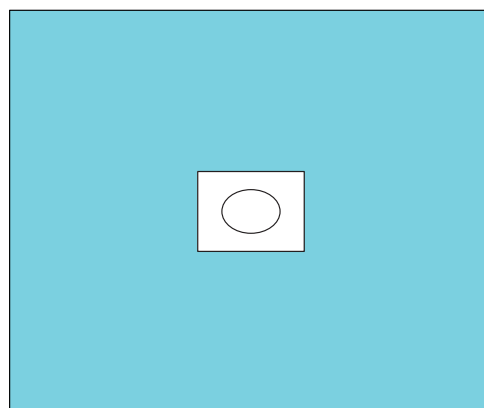

ADHESIVE EPIDURAL DRAPE

915447

36/216

- 75x80 cm, 6x15 cm

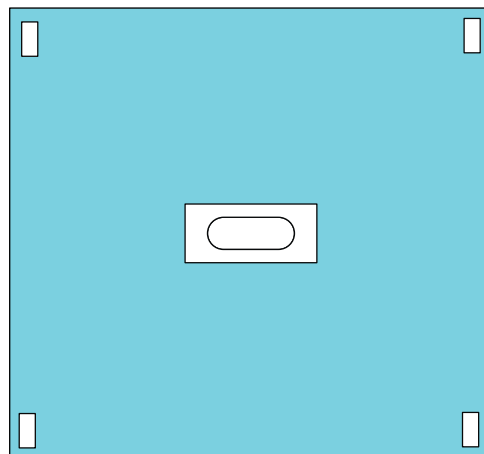

ADHESIVE APERTURE DRAPE

935569

26/52

904744 120x150 cm, 5x7 cm, 65 cm from top

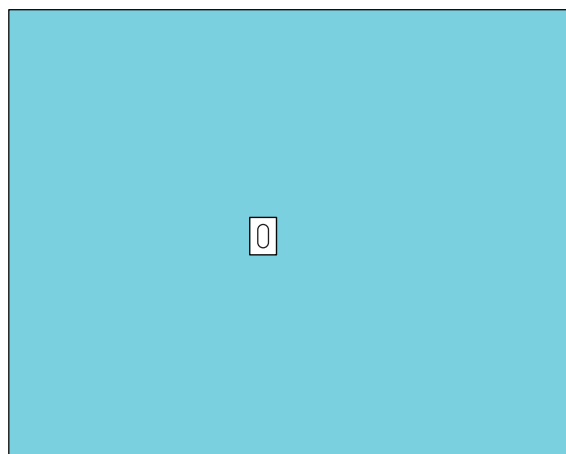

ADHESIVE APERTURE DRAPE

80664575

24/96

8253 45x75 cm, 6 cm

/420

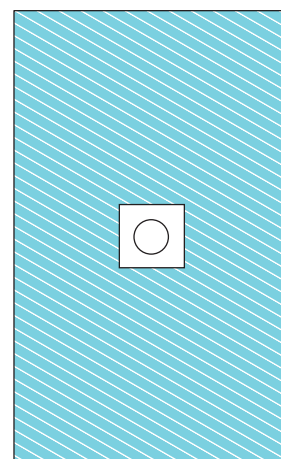

ADHESIVE APERTURE DRAPE

80666075

45/270

- 60x75 cm, 10 cm

/280

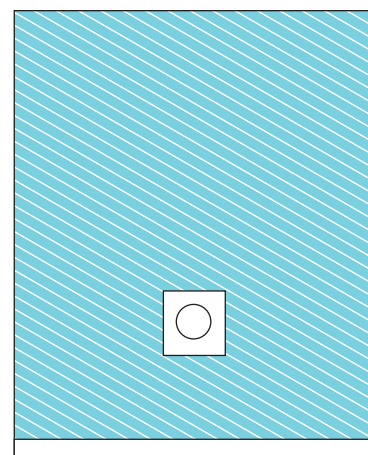

ADHESIVE APERTURE DRAPE

80687590

45/180

8017 75x90 cm, 6 cm

/210

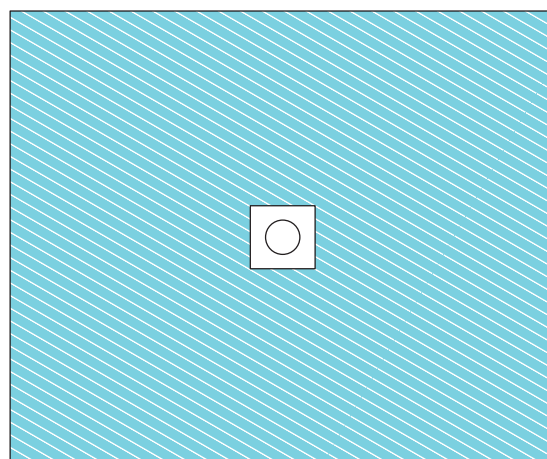

ADHESIVE APERTURE DRAPE

84521200

/60

924407 120x150 cm, apertured incise 7.5 cm, wrapped

/60

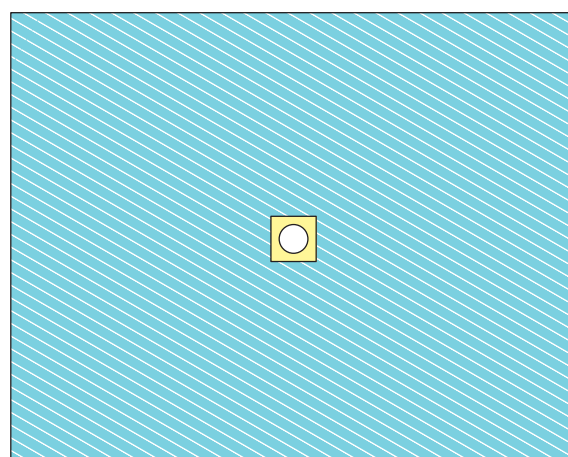

---

**ADHESIVE APERTURE DRAPE**

**84551230** /60

- 75x100 cm, apertured incise 6x12 cm, wrapped -

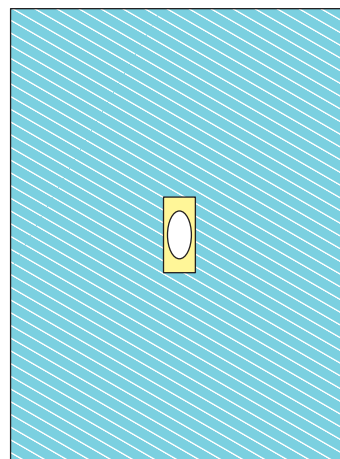

## **DETAILED SECURITY FOR EVERY SPECIALITY**

The operating room is often a very stressful environment where a lot of factors have to work in harmony so the surgical team are able to perform at their very best.

At Mölnlycke Health Care we are dedicated to creating peace of mind in the operating room and our comprehensive range of BARRIER drapes and sets is a perfect proof of this. There is a vast range of all-in-one designs to accommodate any surgical speciality. They are all quick and easy to drape thanks to their smart foldings and self-explanatory instruction labels.

Many of our speciality specific drapes have different integrated solutions such as pouches, cord holders, elasticated fenestrations and non-slip pads. All functions are there to enable the professionals to focus on what they do best, every day.



## ANGIOGRAPHY SETS AND DRAPES

**ANGIOGRAPHY SET**

**698220**

5/10

- 958283 1 angiography drape 240x330 cm, patch 70x70 cm, 2 apertures 7x10 cm
- 947064 1 adhesive towel 50x50 cm
- 990375 1 banded bag 140 cm
- 830204 1 absorption pad 34x50 cm
- 914080 1 table cover 150x190 cm, 75x190 cm absorbent

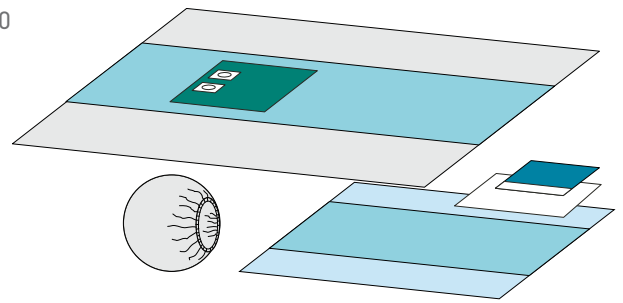

**ANGIOGRAPHY RADIALIS SET**

**698260**

5/10

- 1 table cover 150x140 cm, 75x140 cm absorbent
- 2 cellulose towel 19x25 cm
- 304998 1 absorption pad 56x80 cm
- 947064 1 adhesive towel 50x50 cm
- 958284 1 angiography drape 240x330 cm, apertures 5x7 cm (2) and 7x9 cm (2)
- 1 table cover 150x140 cm, 75x140 cm absorbent

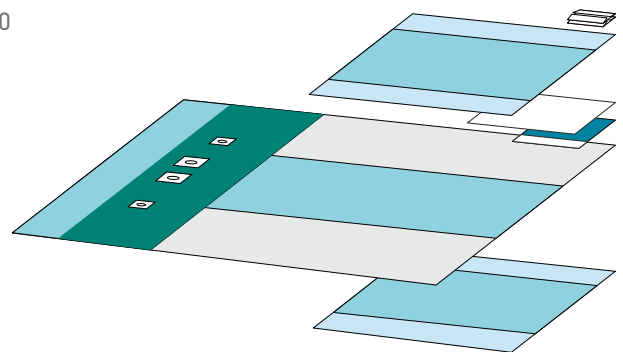

**ANGIOGRAPHY SET**

**904730**

6/12

- 2 cellulose towel 19x25 cm
- 914079 1 table cover 100x150 cm, 75x150 absorbent
- 304998 1 absorption pad 56x80 cm
- 947064 1 adhesive towel 50x50 cm
- 904706 1 angiography drape 240x330 cm, patch 70x70 cm, 2 apertures 7x10 cm
- 1 table cover 150x140 cm, 75x140 cm absorbent

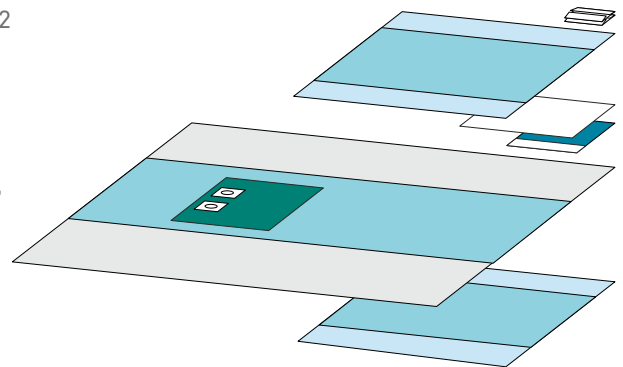

**ANGIOGRAPHY SET**

**904748**

3/6

- 914080 1 table cover 150x190 cm, 75x190 cm absorbent
- 914079 1 table cover 75x150 cm, 75x150 cm absorbent
- 2 cellulose towel 19x25 cm
- 2 handtowel 45x33 cm
- 750104 1 surgical gown LL
- 750110 1 surgical gown XLL
- 947064 1 adhesive towel 50x50 cm
- 304998 1 absorption pad 56x80 cm
- 904706 1 angiography drape 240x330 cm, patch 70x70 cm, 2 apertures 7x10 cm
- 914080 1 table cover 150x190 cm, 75x190 cm absorbent

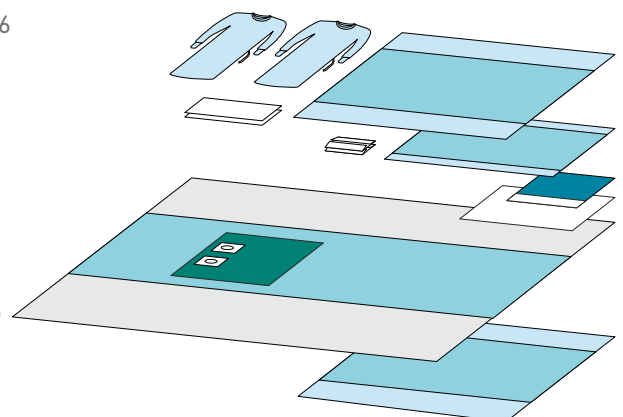

**FEMORAL ANGIOGRAPHY DRAPE II**

210

/13

- 9210 1 angiography drape 203x325 cm, reinforcement 91x117 cm, aperture 6x9 cm
- 9845 1 table cover 140x180 cm, 66x180 cm absorbent

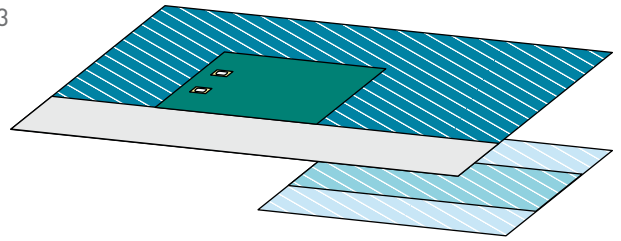

**FEMORAL ANGIOGRAPHY SET**

84511501

/10

- 924111 1 angiography drape 185x300 cm, reinforcement 91x122 cm, aperture 6,5 cm
- 80508065 1 banded bag 90 cm
- 8045 1 table cover 140x180 cm, 66x180 cm absorbent

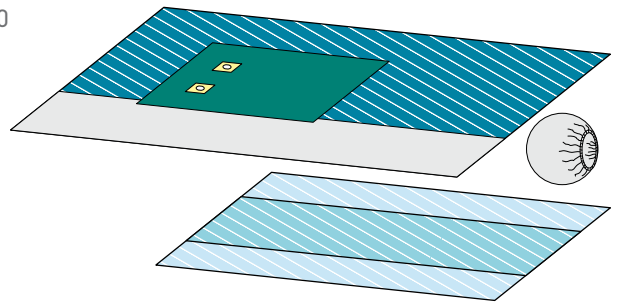



ANGIOGRAPHY DRAPE

828300

10/20

958283 240x330cm, patch 70x70 cm, 2 apertures 7x10 cm

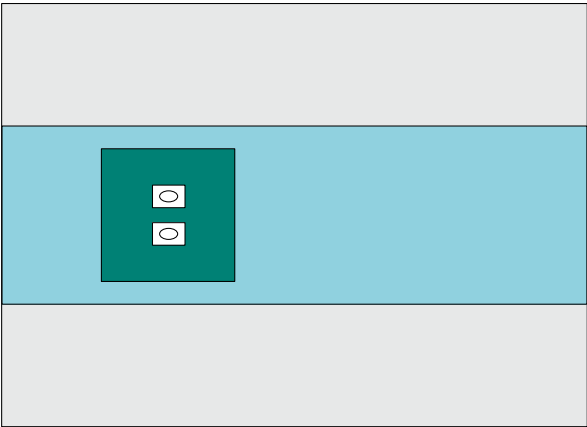

ANGIOGRAPHY DRAPE

211

/16

9411 203x371 cm, reinforcement 91x239 cm,  
aperture 6x9 cm, wrapped

/12

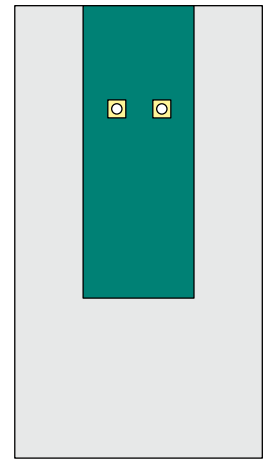

ANGIOGRAPHY DRAPE

1210

/13

9510 208x279 cm, reinforcement 86x91 cm,  
aperture 6x9 cm, wrapped

/20

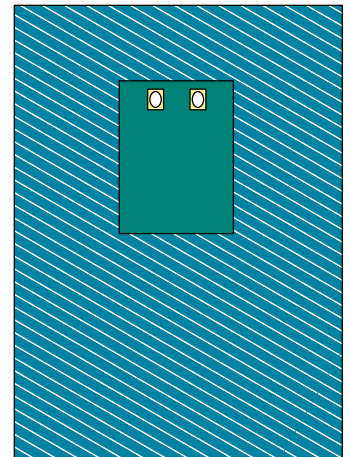

BRACHIAL ANGIOGRAPHY DRAPE

1212

/18

9205 112x145 cm, reinforcement 61x60 cm,  
aperture 6 cm, wrapped

/60

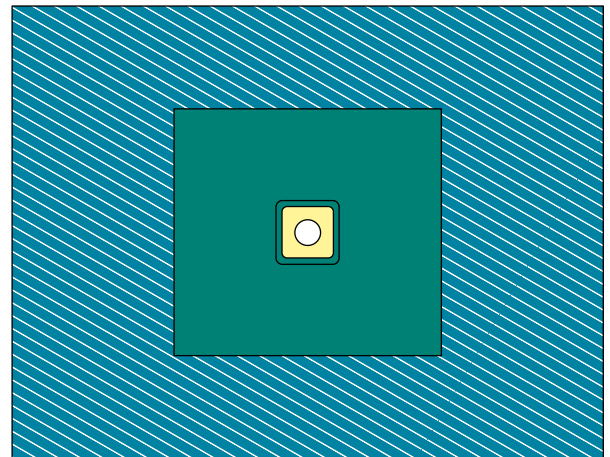

BRACHIAL ANGIOGRAPHY DRAPE

80005137

/8

80008005 198x279 cm, reinforcement 86x91 cm,  
aperture 6x9 cm, wrapped

/120

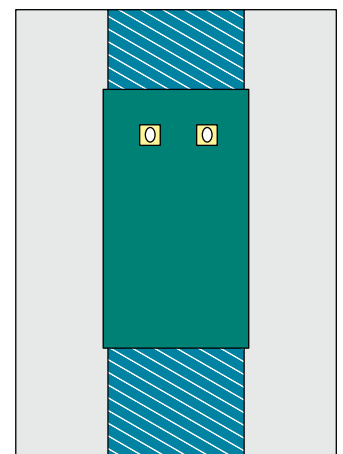

ANGIOGRAPHY DRAPE

80051351

/7

8008003 200x340 cm, reinforcement 91x160 cm,  
aperture 6x9 cm, wrapped

/120

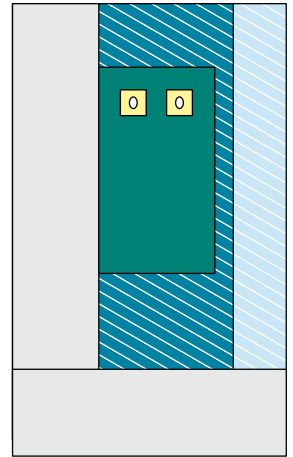

ANGIOGRAPHY DRAPE

80051382

/8

80080062 204x289 cm, reinforcement 91x160 cm,  
aperture 6x9 cm, wrapped

/120

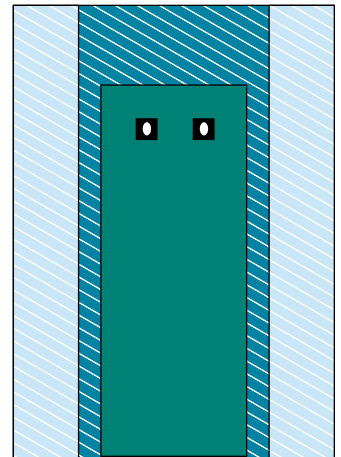



## CARDIOVASCULAR SETS AND DRAPES

**ACUTE THORACIC SET**

**669600**

3/6

- 996109 1 mayo stand cover reinforced 79x145 cm, 65x85 cm absorbent
- 1 genital cover 18x40 cm
- 6 cellulose towel 19x25 cm
- 824098 2 tube holder velcro 2,5x30 cm
- 910598 1 adhesive towel 75x75 cm
- 1 defibrillator bag 33x38 cm
- 911510 2 op-tape 9x49 cm
- 966960 1 acute thoracic drape 200/300x340 cm, incise area 37x65 cm
- 914081 1 table cover 150x240 cm, 75x240 cm absorbent

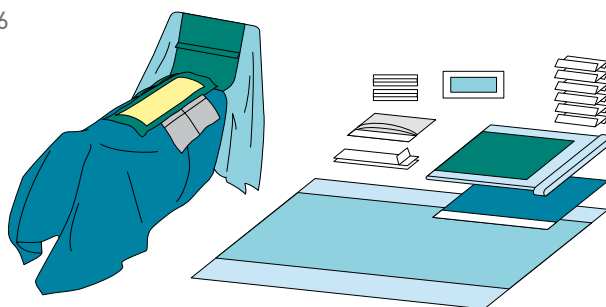

**CARDIOVASCULAR SET**

**694640**

3/6

- 996109 1 mayo stand cover reinforced 79x145 cm, 65x85 cm absorbent
- 6 cellulose towel 19x25 cm
- 914080 1 table cover 150x190 cm, 75x190 cm absorbent
- 1 defibrillator bag 33x38 cm
- 824098 1 defibrillator bag 33x38 cm
- 911510 2 tube holder velcro 2,5x30 cm
- 941005 3 op-tape 9x49 cm
- 991005 2 feet socks green
- 910598 2 feet socks transparent
- 988795 1 lower vascular drape 200x260 cm, split 20x102 cm
- 966946 1 thoracic drape 200/300x330 cm, incise area 32x40 cm
- 914081 1 table cover 150x240 cm, 75x240 cm absorbent

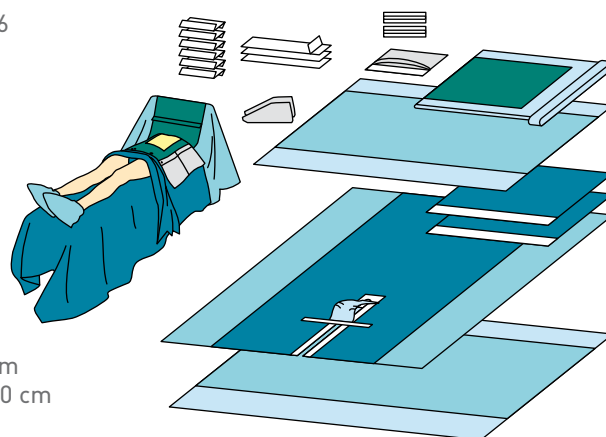

**CARDIOVASCULAR SET**

**694650**

3/6

- 996109 1 mayo stand cover reinforced 79x145 cm, 65x85 cm absorbent
- 6 cellulose towel 19x25 cm
- 914080 1 table cover 150x190 cm, 75x190 cm absorbent
- 1 defibrillator bag 33x38 cm
- 824098 2 tube holder velcro 2,5x30 cm
- 911510 3 op-tape 9x49 cm
- 941005 2 feet socks green
- 991005 2 feet socks transparent
- 910598 2 adhesive towel 75x75 cm
- 988795 1 lower vascular drape 200x260 cm, split 20x102 cm
- 966949 1 thoracic drape 175/300x350 cm, incise area 32x40 cm
- 914081 1 table cover 150x240 cm, 75x240 cm absorbent

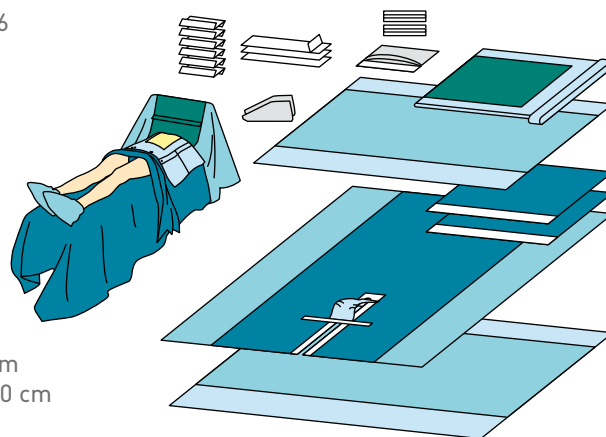

**CARDIOVASCULAR SET**

**694700**

3/6

- 996109 1 mayo stand cover reinforced 79x145 cm, 65x85 cm absorbent
- 8 cellulose towel 19x25 cm
- 824098 2 tube holder velcro 2,5x30 cm
- 911510 3 op-tape 9x49 cm
- 968088 1 table cover 200x280 cm
- 914080 1 table cover 150x190 cm, 75x190 cm absorbent
- 941005 2 feet socks green
- 978001 1 genital cover
- 910598 1 adhesive towel 75x75 cm
- 927069 3 adhesive towel 100x100 cm
- 1 defibrillator bag 33x38 cm
- 969476 1 cardiovascular drape 200/300x345 cm, incise area 32x40 cm, 17x107 cm [2]
- 914081 1 table cover 150x240 cm, 75x240 cm absorbent

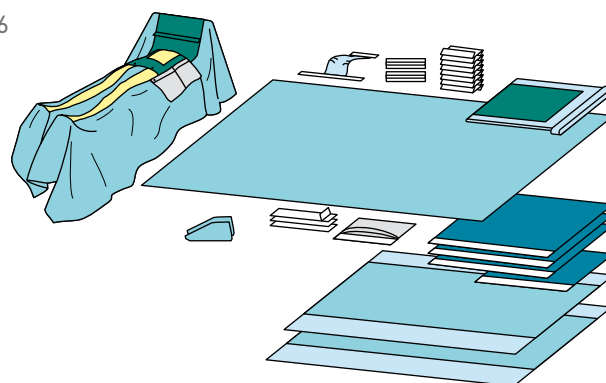

CARDIOVASCULAR UNIVERSAL SET

694730

3/6

- 996109 1 mayo stand cover reinforced 79x145 cm, 65x85 absorbent
- 914080 1 table cover 150x190 cm, 75x190 cm absorbent
- 988795 1 lower vascular drape 200x260 cm, split 20x102 cm
- 824098 2 tube holder velcro 2,5x30 cm
- 6 cellulose towel 19x25 cm
- 2 defibrillator bag 33x38 cm
- 910598 1 adhesive towel 75x75 cm
- 911510 3 op-tape 9x49 cm
- 941005 2 feet socks green
- 917069 2 adhesive towel reinforced 100x100 cm
- 967772 1 adhesive op-sheet standard 175x175 cm
- 937782 1 adhesive op-sheet orthopaedic 300x175 cm
- 914081 1 table cover 150x240 cm, 75x240 cm absorbent

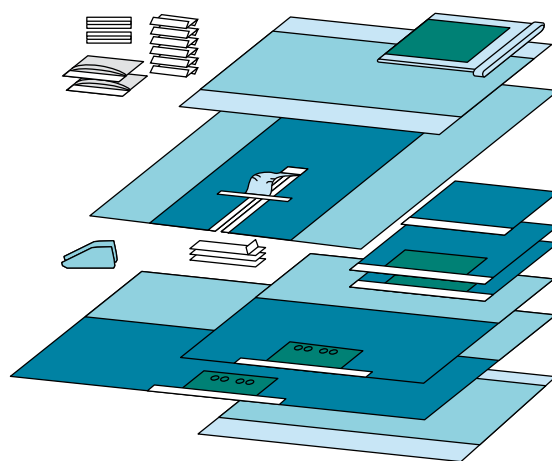

VU-THRU CARDIOVASCULAR UNIVERSAL SET II 173

/4

- 9455 8 adhesive utility drape 76x52 cm
- 1 transparent impervious drape 102x145 cm
- 1 suture bag 16.5x28.5 cm
- 9544 1 mayo stand cover 58x137 cm, 46x56 cm absorbent
- 9473 1 bilateral split sheet 213x206 cm, split 15x51 cm
- 9573 1 vu-thru cardiovascular split sheet 203/280x340, split 15x213 cm
- 9528 1 patient drape 146x196 cm
- 9376 1 table cover reinforced 178x280 cm, 91x183 cm absorbent

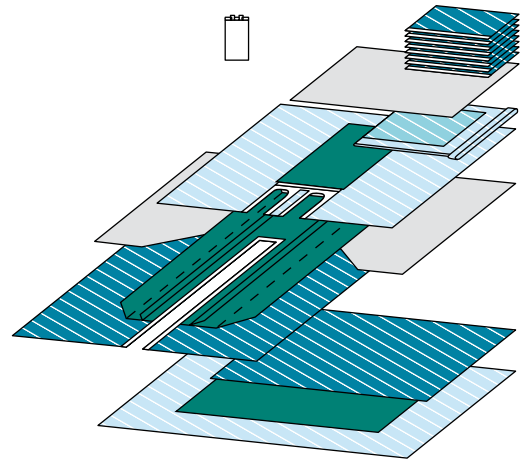

CARDIAC BILATERAL SPLIT SHEET, FOOT COVERS 80097461

80097461

/12

- 2 cellulose towel 50x50 cm
- 924601 2 foot cover 104x114 cm
- 9473 1 bilateral split sheet 213x206 cm, reinforcement 61x120 cm, split 15x51 cm
- 1 wrap 86x86 cm

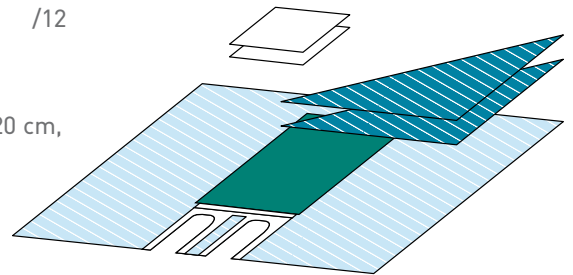

**CARDIOVASCULAR LEG DRAPE**

**778500**

38/76

967785 150x160 cm

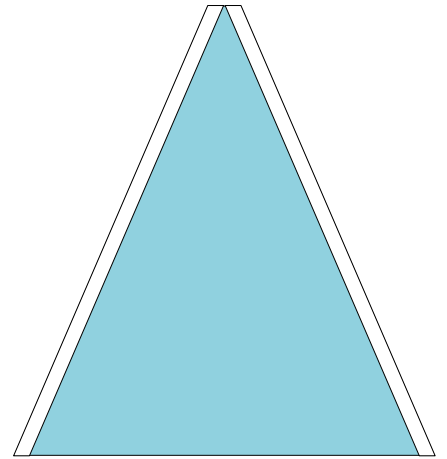

**THORACIC DRAPE**

**824600**

6/12

966946 200/300x330 cm, incise area 32x40 cm

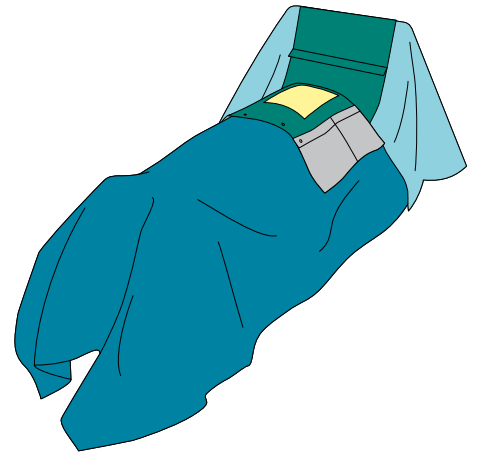

**LOWER VASCULAR DRAPE**

**824700**

13/26

988795 200x260 cm, split 20x102cm

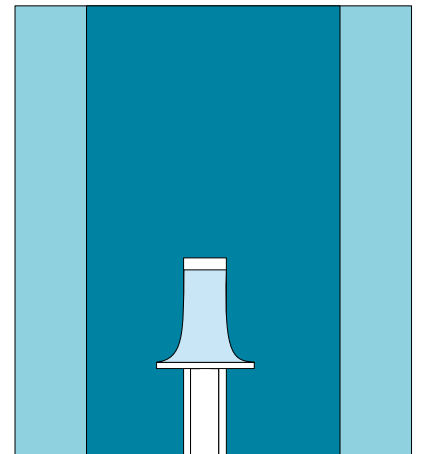



**VU-THRU CARDIOVASCULAR SPLIT SHEET**    **373**    /6  
 9573    203/280x340, split 15x213 cm, wrapped    /9

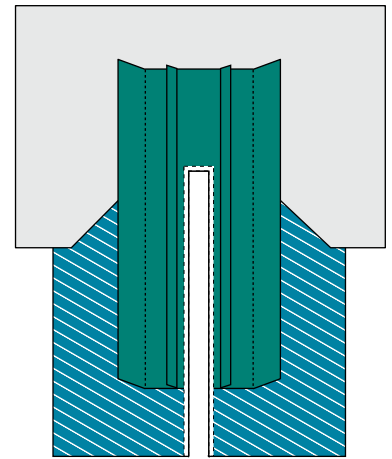

**CARDIOVASCULAR DRAPE**    **1274**    /7  
 9474    206/274x389 cm, incise areas 39x39 cm and 62x105 cm, wrapped    /8

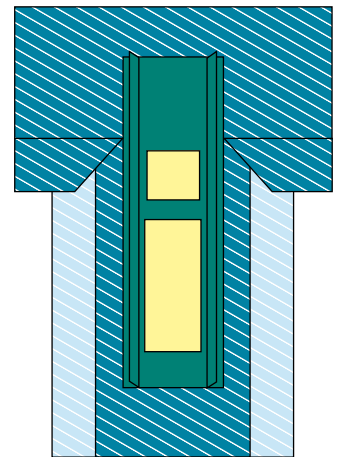

**CARDIOVASCULAR DRAPE**    **1278**    /8  
 9678    206/274x345 cm, incise areas 23x39 cm and 46x97 cm, wrapped    /12

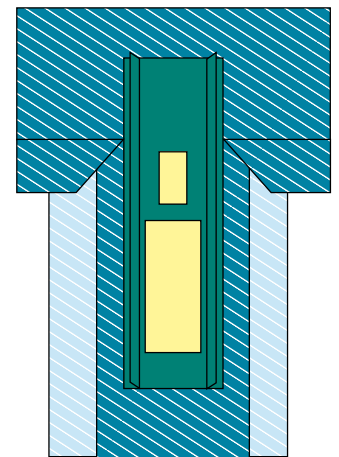

**BILATERAL SPLIT SHEET**    **3930**    /26  
 9473    213x206 cm, reinforcement 61x120 cm, split 15x51 cm, wrapped    /40

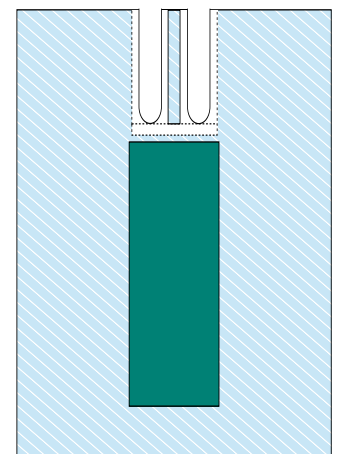

**CARDIAC DRAPE**

**8005060**

/5

80508076 183/300x377 cm, reinforcement 52x75cm,  
aperture 9x30 cm, wrapped

/13

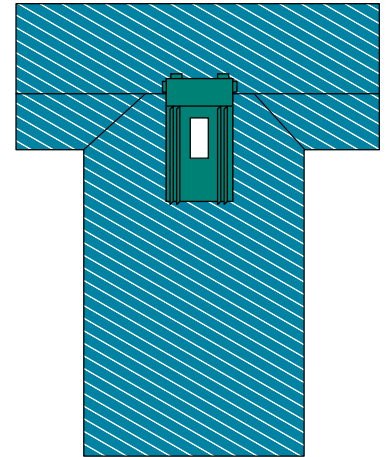

**CARDIAC DRAPE**

**8097440**

/5

80008000 183/300x341 cm, incise area 25x37 cm,  
wrapped

/5

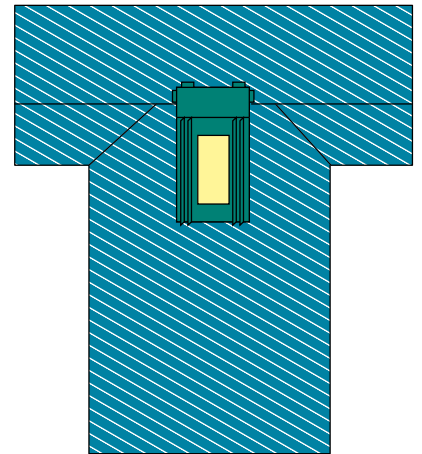

**THORACIC DRAPE**

**8097450**

/7

928601 183/257x340 cm, reinforcement 71x85 cm,  
incise area 42x35 cm, wrapped

/10

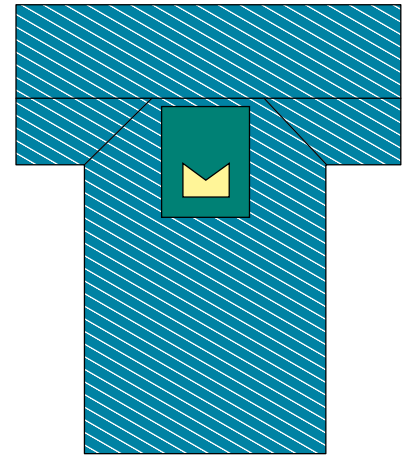



## ENT- DENTAL SETS AND DRAPES

**DENTAL SET**

**306480**

25/50

- 815330 2 tube/camera cover 8x120 cm
- 1 op-tape 9x24,5 cm
- 900076 1 aperture drape 100x150 cm, aperture 13x9,5 cm
- 1 table cover 75x100 cm

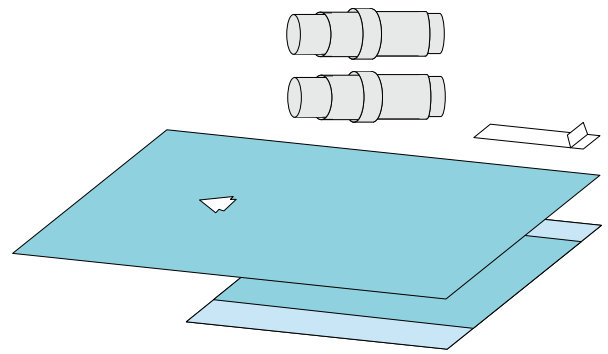

**PLASTIC SURGERY SET**

**692300**

9/18

- 2 cellulose towel 19x25 cm
- 956923 1 aperture drape 150x175 cm, aperture 13x17 cm
- 914080 1 table cover 150x190 cm, 75x190 cm absorbent

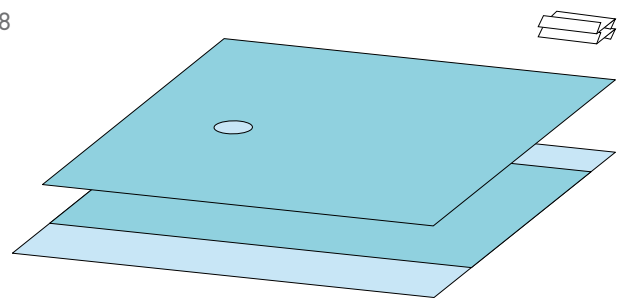

**DENTAL SET**

**694000**

14/28

- 2 op-tape 9x24,5 cm
- 815330 2 tube/camera cover 8x120 cm
- 968004 2 utility drape 45x75 cm
- 910176 1 aperture drape 150x150 cm, aperture 13x10 cm
- 1 table cover 75x100 cm

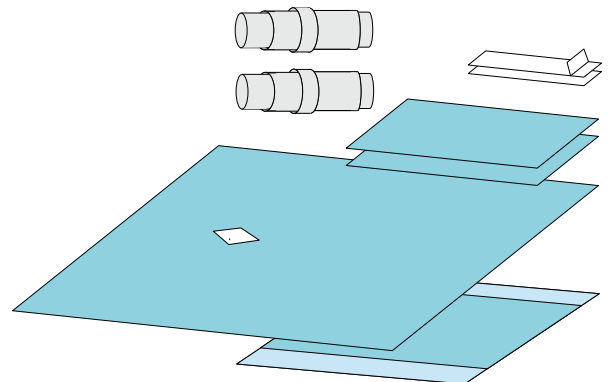

**HEAD SET**

**696940**

6/12

- 996106 1 mayo stand cover 79x145 cm, 65x85 cm absorbent
- 911510 1 op-tape 9x49 cm
- 988269 1 head drape 150x175 cm and 106x103 cm
- 967772 1 adhesive op-sheet 175x175 cm
- 914080 1 table cover 150x190 cm, 75x190 cm absorbent

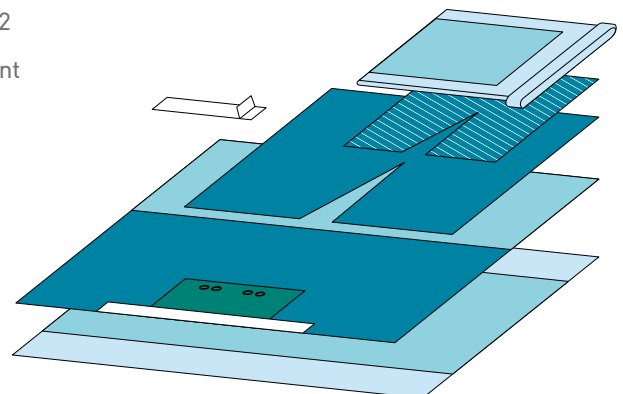

ENT SET

697000

7/14

- 996109 1 mayo stand cover reinforced 79x145 cm, 65x85 cm absorbent
- 4 cellulose towel 19x25 cm
- 910185 1 op-sheet 150x175 cm
- 910598 1 adhesive towel 75x75 cm
- 911510 2 op-tape 9x49 cm
- 980789 1 adhesive split sheet 150x125 cm, split 7x45 cm
- 914080 1 table cover 150x190 cm, 75x190 cm absorbent

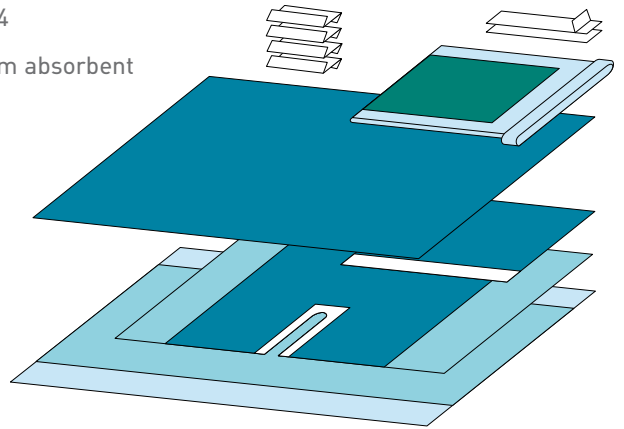

NECK SET

697250

7/14

- 996106 1 mayo stand cover 79x145 cm, 65x85 cm absorbent
- 4 cellulose towel 19x25 cm
- 911510 2 op-tape 9x49 cm
- 969700 1 body drape 175x230 cm, split 20x20 cm
- 969710 1 head drape 260x150 cm, split 20x65 cm
- 914080 1 table cover 150x190 cm, 75x190 cm absorbent

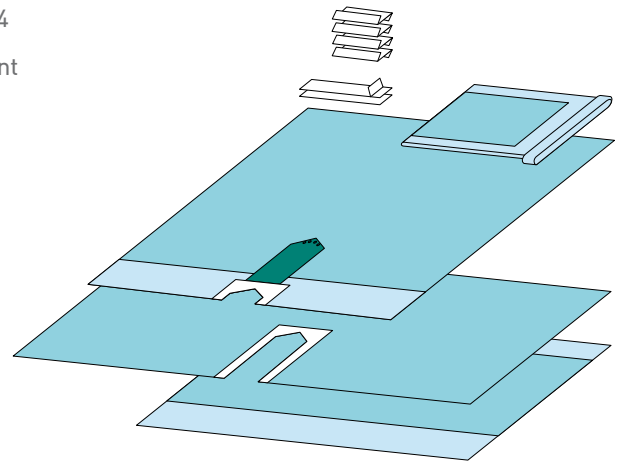

THYROID SET

697260

7/14

- 996106 1 mayo stand cover 79x145 cm, 65x85 cm absorbent
- 4 cellulose towel 19x25 cm
- 911510 1 op-tape 9x49 cm
- 824098 1 tube holder velcro 2,5x30 cm
- 969711 1 adhesive aperture drape 200/280x350 cm, aperture 11x11 cm
- 914080 1 table cover 150x190 cm, 75x190 cm absorbent

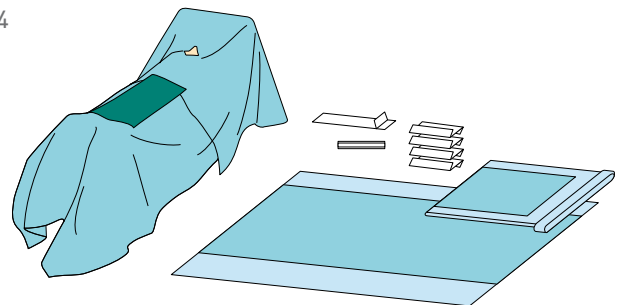

ENT SET

697640

8/16

- 2 cellulose towel 19x25 cm
- 911510 1 op-tape 9x49 cm
- 967640 1 adhesive aperture drape, 200x240 cm, aperture 7 cm
- 914080 1 table cover 150x190 cm, 75x190 cm absorbent

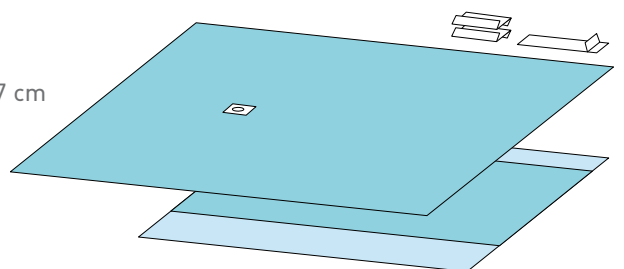

## ENT SET

915330

7/14

996106	1 mayo stand cover 79x145 cm, 65x85 cm absorbent
-	4 cellulose towel 19x25 cm
911510	2 op-tape 9x49 cm
910519	1 op-towel 75x90 cm
910200	1 adhesive towel 90x75 cm
980796	1 adhesive split sheet 150x260 cm, split 7x65 cm
914080	1 table cover 150x190 cm, 75x190 cm absorbent

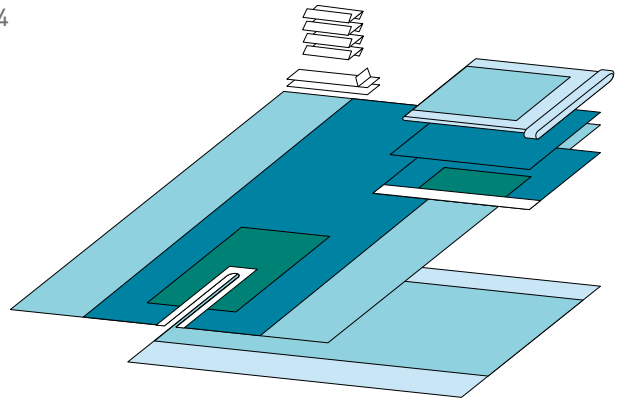

**HEAD/NECK SET II**

**175** /11

- 9544 1 mayo stand cover 58x137 cm, 45x56 cm absorbent
- 1 suture bag 16,5x30,5 cm
- 1 adhesive head drape 127x79 cm, reinforcement 30x84 cm
- 9585 1 ENT split sheet 196x290 cm, split 6x63 cm
- 9660 1 table cover 140x216 cm, 66x216 cm absorbent

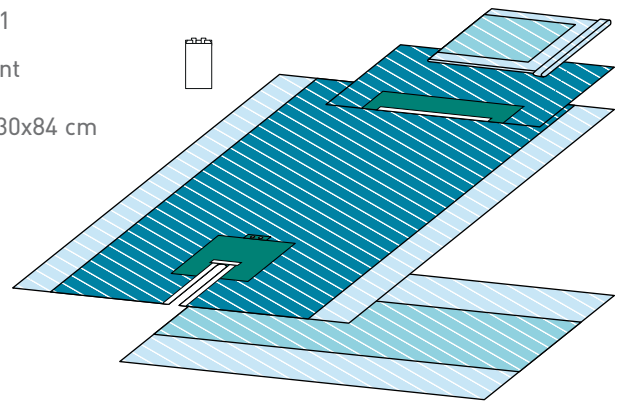

**ENT SET I**

**1218** /9

- 9544 1 mayo stand cover 58x137 cm, 45x56 cm absorbent
- 9517 1 adhesive head drape w/ turban 104x114 cm
- 1 suture bag 16,5x30,5 cm
- 9518 1 ENT split sheet 196x290 cm, split 6x63 cm
- 9660 1 table cover 140x215 cm, 66x215 cm absorbent

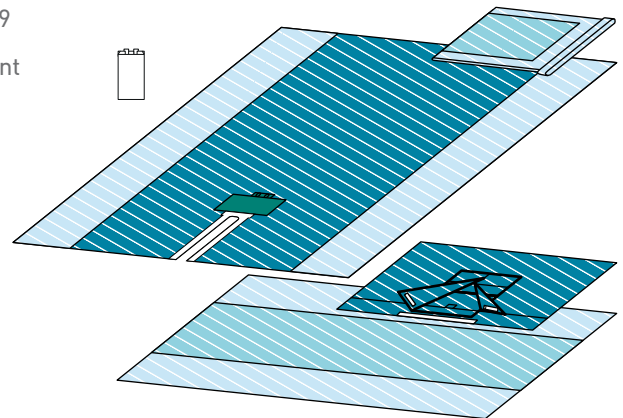

**HEAD TURBAN SET**

**80011660** /11

- 8084 1 adhesive head drape w/ turban wrap 104x128 cm
- 70057496 1 adhesive op-sheet 190x183 cm
- 1 wrap 86x86 cm

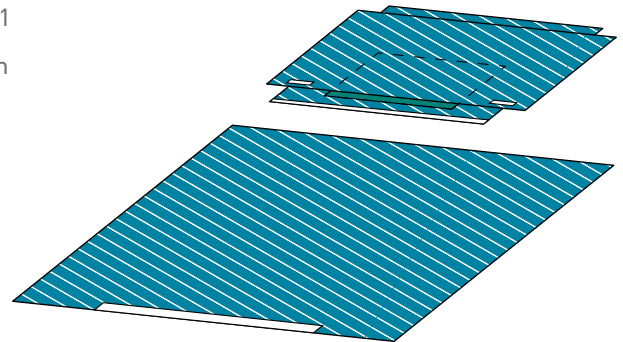

**BASIC SET**

**80011721** /12

- 922001 1 patient drape 100x150 cm
- 80057495 1 adhesive utility drape 114x104 cm
- 921424 1 adhesive patient drape 150x173 cm
- 1 wrap 86x86 cm

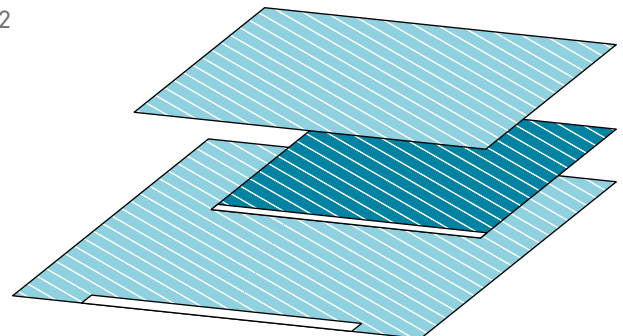

**HEAD TURBAN SET**

80574671

/8

- 70057496 1 adhesive op-sheet 190x183 cm
- 8084 1 adhesive head drape w/ turban wrap 104x128 cm
- 9660 1 table cover 140x215 cm, 66x215 cm absorbent

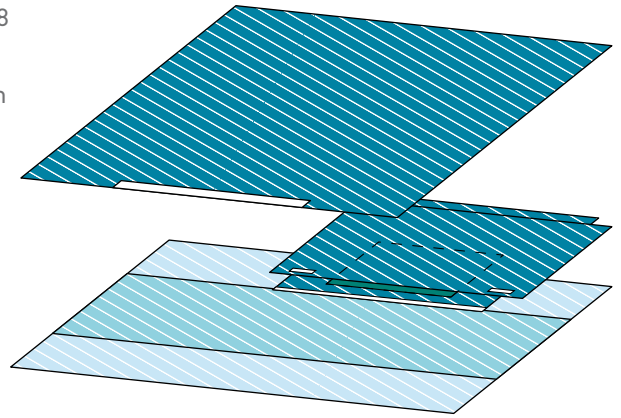

**HEAD/NECK SET**

84511111

/10

- 80008039 1 adhesive head drape 130x92 cm, reinforcement 23x85 cm
- 920411 1 ENT split sheet 183x290 cm, split 15x50 cm
- 9660 1 table cover 140x215 cm, 66x215 cm absorbent

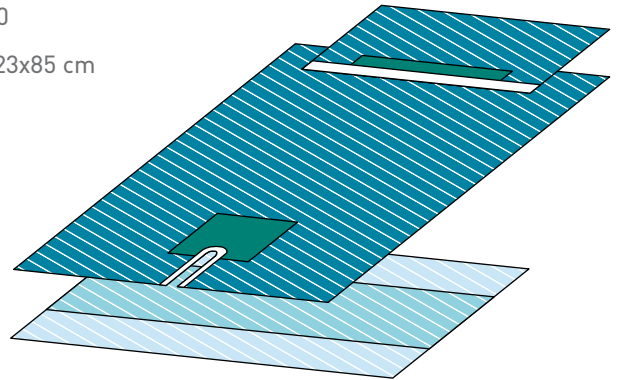

**ENT SET**

84511190

/14

- 2 op-tape 8x45 cm
- 928603 1 adhesive aperture drape 183x210 cm, reinforcement 61x60 cm, apertured Incise 6 cm
- 921700 1 table cover 140x160 cm, 66x160 cm absorbent

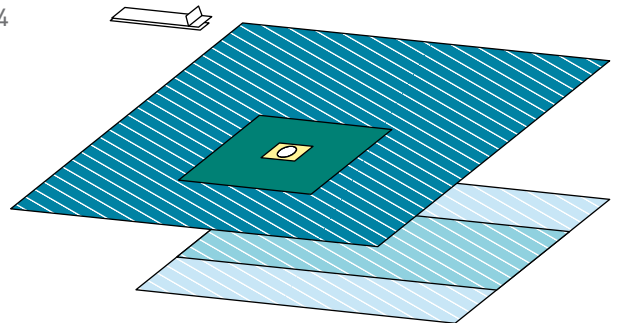



HEAD DRAPE

826900

14/28

988269 150x175 cm, 106x103 cm + 1 op-tape 9x49 cm

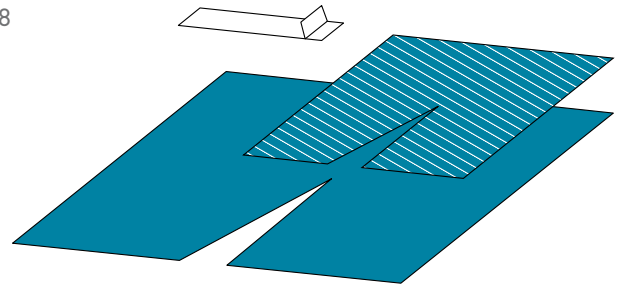

## NECK/THYROID DRAPE

286

/15  
/18

9386 183/257x302 cm, aperture 11x11 cm, wrapped

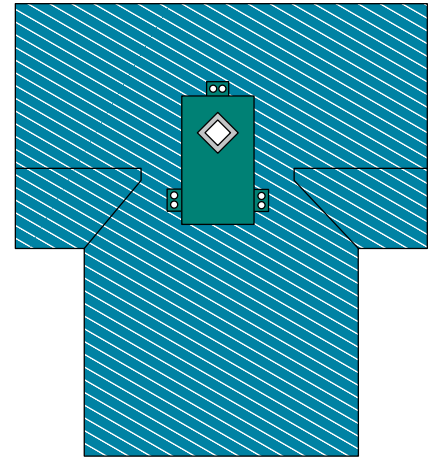



## GENERAL SETS AND DRAPES

## LAPAROSCOPY SET ABDO-PERINEAL

694240

5/10

- 4 cellulose towel 19x25 cm
- 911510 1 op-tape 9x49 cm
- 824098 1 tube holder velcro 2,5x30 cm
- 910598 1 adhesive towel 75x75 cm
- 944200 1 laparoscopy drape 250/175/270x260 cm, apertures 25x30 cm and 13x24 cm
- 914080 1 table cover 150x190 cm, 75x190 cm absorbent

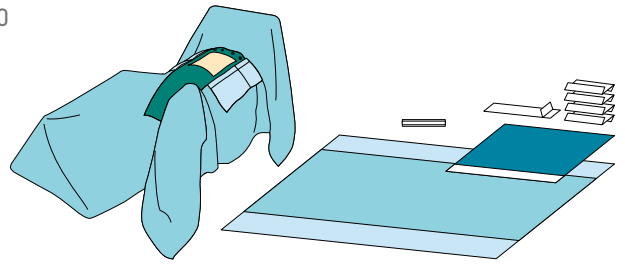

## LAPAROSCOPY SET ABDO-PERINEAL

694241

5/10

- 996106 1 mayo stand cover 79x145 cm, 65x85 cm absorbent
- 4 cellulose towel 19x25 cm
- 911510 1 op-tape 9x49 cm
- 824098 1 tube holder velcro 2,5x30 cm
- 910598 1 adhesive towel 75x75 cm
- 944200 1 laparoscopy drape 250/175/270x260 cm, apertures 25x30 cm and 13x24 cm
- 914080 1 table cover 150x190 cm, 75x190 cm absorbent

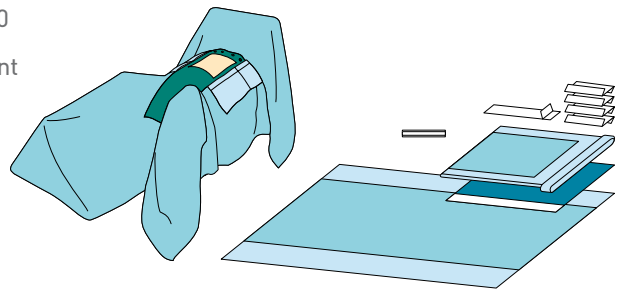

## LAPAROSCOPY SET

694245

5/10

- 996106 1 mayo stand cover 79x145 cm, 65x85 cm absorbent
- 4 cellulose towel 19x25 cm
- 911510 1 op-tape 9x49 cm
- 824098 1 tube holder velcro 2,5x30 cm
- 815332 1 tube/camera cover perforated tip 12x240 cm
- 944205 1 laparoscopy drape 250/175/270x260 cm, aperture 25x30 cm
- 914080 1 table cover 150x190 cm, 75x190 cm absorbent

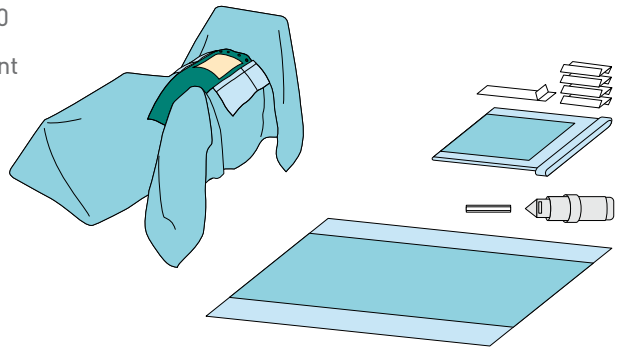

## LAPAROSCOPY SET

694265

5/10

- 996106 1 mayo stand cover 79x145 cm, 65x85 cm absorbent
- 4 cellulose towel 19x25 cm
- 911510 1 op-tape 9x49 cm
- 824098 1 tube holder velcro 2,5x30 cm
- 815332 1 tube/camera cover perforated tip 12x240 cm
- 954225 1 laparoscopy drape 175/250x325 cm, aperture 25x30 cm
- 914080 1 table cover 150x190 cm, 75x190 cm absorbent

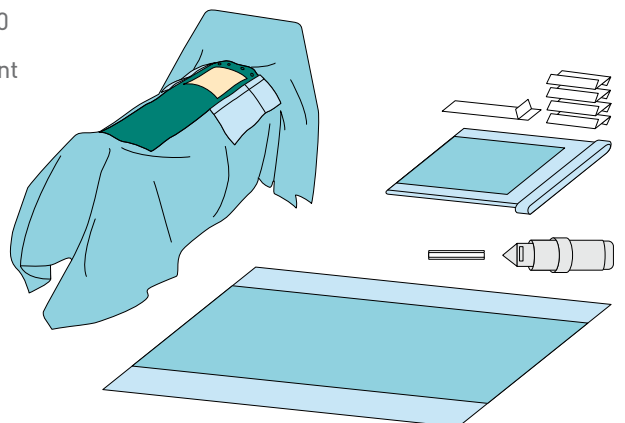

**VARICOSE VEIN SET**

**694800**

5/10

- 2 cellulose towel 19x25 cm
- 914079 1 table cover 100x150 cm, 75x150 cm absorbent
- 911510 1 op-tape 9x49 cm
- 950798 1 adhesive split sheet 200x260 cm, split 20x102 cm
- 967773 1 adhesive op-sheet 240x150 cm
- 914080 1 table cover 150x190 cm, 75x190 cm absorbent

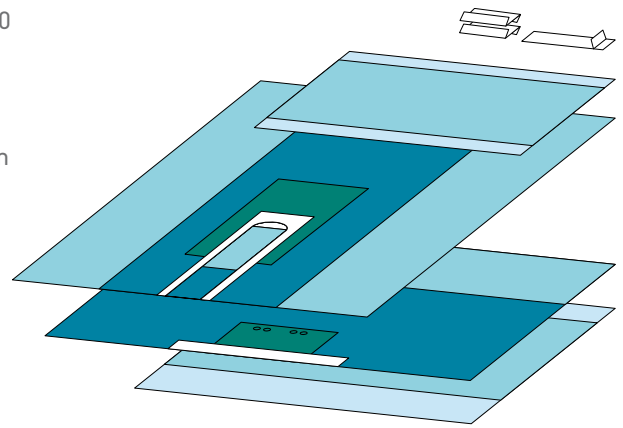

**LAPAROTOMY SET**

**697100**

7/14

- 996106 1 mayo stand cover 79x145 cm, 65x85 cm absorbent
- 4 cellulose towel 19x25 cm
- 911510 1 op-tape 9x49 cm
- 980250 1 laparotomy drape 200x315 cm, aperture 11x22 cm
- 914080 1 table cover 150x190 cm, 75x190 cm absorbent

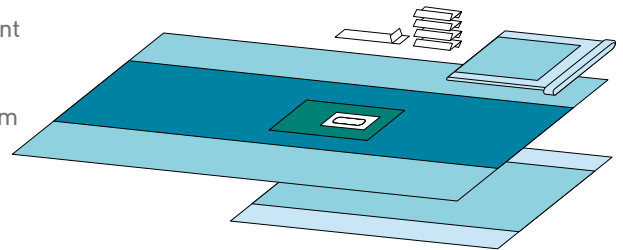

**BASIC SPLIT SHEET SET**

**697200**

6/12

- 996109 1 mayo stand cover reinforced 79x145 cm, 65x85 cm absorbent
- 4 cellulose towel 19x25 cm
- 980792 1 adhesive split sheet 230x150 cm, split 7x65 cm
- 911510 2 op-tape 9x49 cm
- 967773 1 adhesive op-sheet 240x150 cm
- 914080 1 table cover 150x190 cm, 75x190 cm absorbent

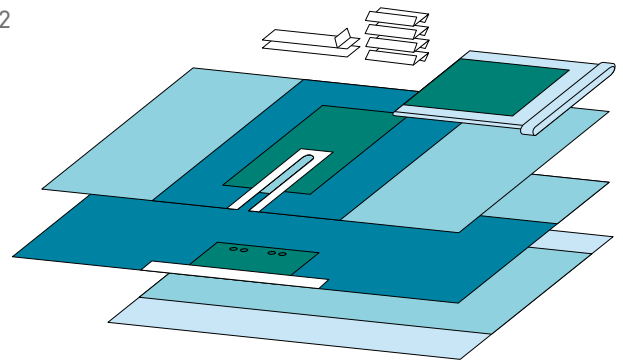

**SPLIT SHEET SET**

**697220**

7/14

- 911510 1 op-tape 9x49 cm
- 980793 1 adhesive split sheet 200x260 cm, split 7x102 cm
- 967776 1 adhesive op-sheet 240x150 cm
- 914080 1 table cover 150x190 cm, 75x190 cm absorbent

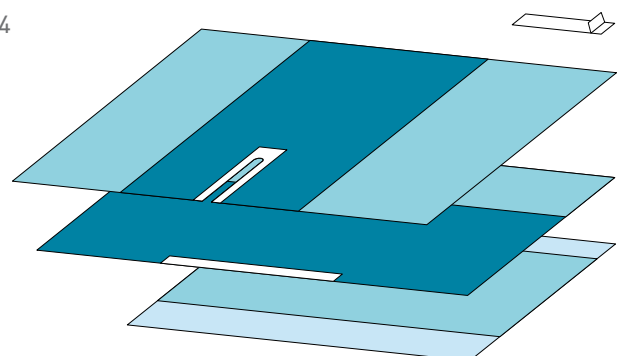

**BASIC APERTURE SET**

**697600**

9/18

- 2 cellulose towel 19x25 cm
- 911510 1 op-tape 9x49 cm
- 980057 1 adhesive aperture drape 200x240 cm, aperture 12 cm
- 914080 1 table cover 150x190 cm, 75x190 cm absorbent

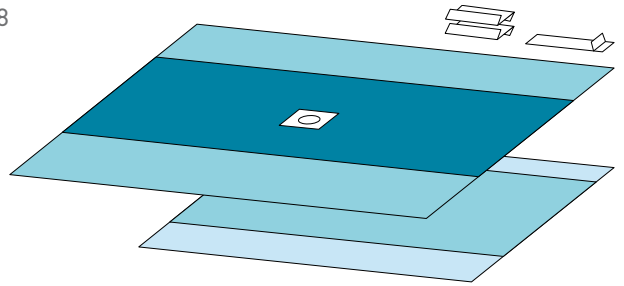

**SPLIT SHEET SET**

**697798**

5/10

- 996109 1 mayo stand cover reinforced 79x145 cm, 65x85 cm absorbent
- 4 cellulose towel 19x25 cm
- 911510 1 op-tape 9x49 cm
- 930200 1 adhesive towel 90x75 cm
- 950798 1 adhesive split sheet 200x260 cm, split 20x102 cm
- 967773 1 adhesive op-sheet 240x150 cm
- 914080 1 table cover 150x190 cm, 75x190 cm absorbent

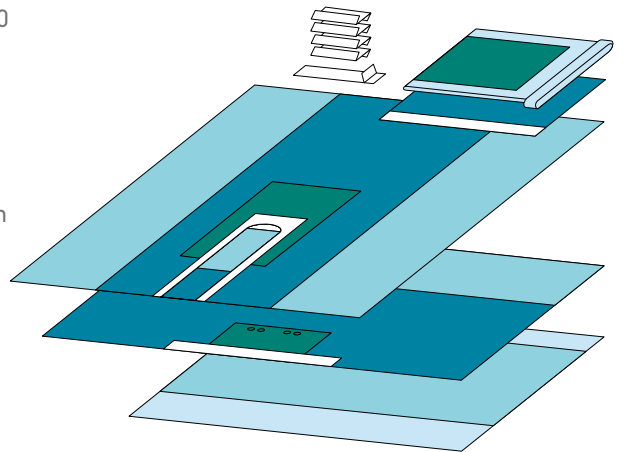

**LAPAROSCOPIC ABDOMINAL SET**

248

/4

- 750102 1 surgical gown L + 1 hand towel 50x50 cm, wrapped
- 750108 2 surgical gown XL
- 10 swab 10x10 cm
- 9544 1 mayo stand cover 58x137 cm, 45x56 cm absorbent
- 9354 4 adhesive utility drape 66x37 cm
- 1 suture bag 16.5x28.5 cm
- 9249 1 laparoscopy/laparotomy drape 196/257x323 cm, reinforcement 46x91 cm, variable aperture 20x31 cm
- 9660 1 table cover 140x215 cm, 66x215 cm absorbent

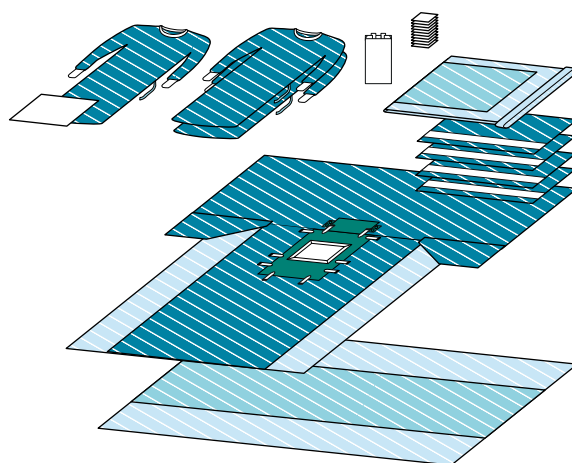

**LAPAROTOMY SET**

1240

/9

- 9544 1 mayo stand cover 58x137 cm, 45x56 cm absorbent
- 9354 4 adhesive utility drape 66x37 cm
- 1 suture bag 16.5x28.5 cm
- 9693 1 laparotomy drape 196/257x323 cm, reinforcement 46x71 cm, variable aperture 8x31 cm
- 9660 1 table cover 140x215 cm, 66x215 cm absorbent

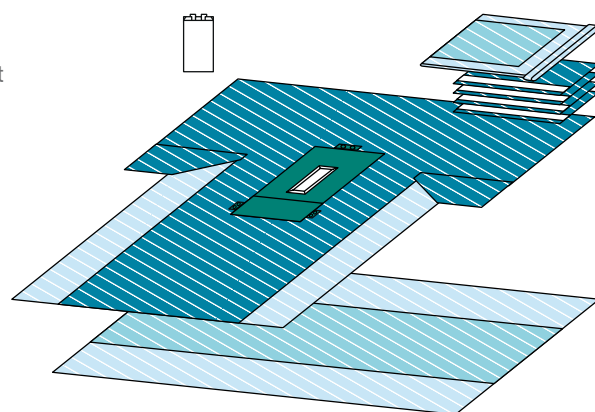

**VARICOSE VEIN SET**

84511401

/12

- 1 op-tape 8x45 cm
- 1 perineal drape 19x35 cm
- 920418 1 adhesive split sheet 220x235 cm, reinforcement 120x150 cm, split 15x80 cm
- 9920 1 adhesive op-sheet 230x160 cm, reinforcement 75x100 cm
- 80008022 1 table cover 140x180 cm, 66x180 cm absorbent

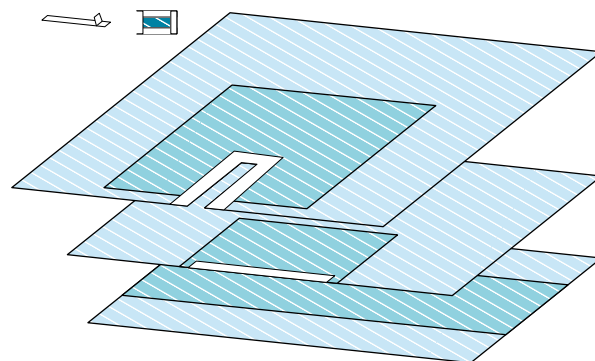

**ABDOMINAL LAPAROSCOPY SET**

84511411

/8

- 2 op-tape 8x45 cm
- 928602 1 abdominal laparoscopy drape w/ leggings 140/240x315 cm, aperture 35x30 cm
- 9660 1 table cover 140x215 cm, 66x215 cm absorbent

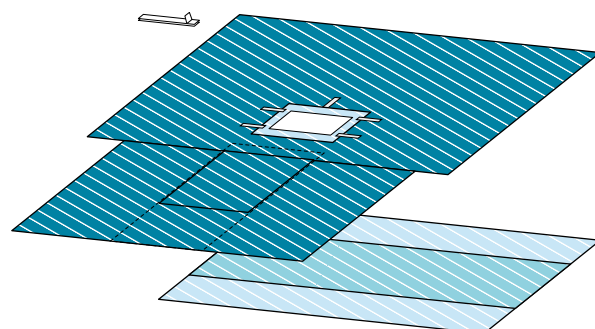

LAPAROTOMY SET

84511532

/10

- 2 op-tape 8x45 cm
- 922309 4 adhesive utility drape 50x30 cm
- 9446 1 laparotomy drape 196/257x323 cm,  
reinforcement 46x71 cm, incise area 23x36 cm
- 9660 1 table cover 140x215 cm, 66x215 cm absorbent

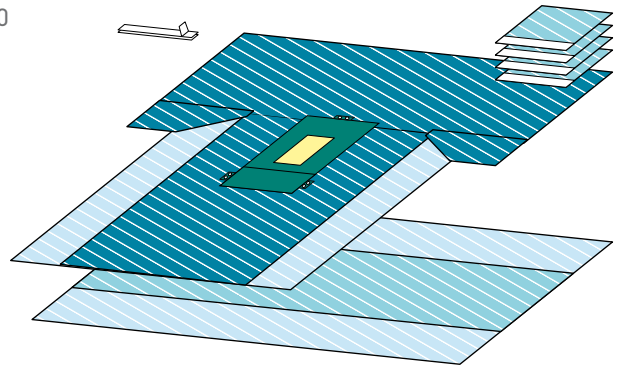



LAPAROTOMY DRAPE

825000

12/24

980250 200x315 cm, 11x22 cm, patch 50x70 cm

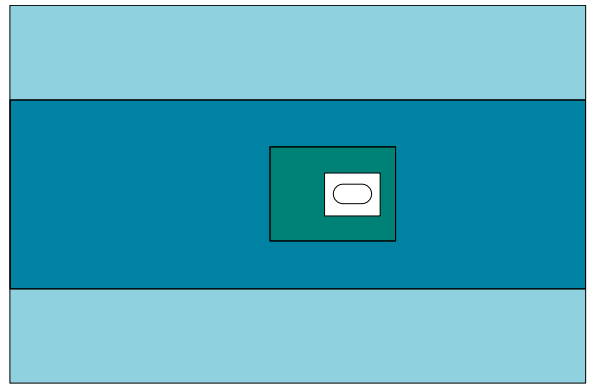

LAPAROTOMY DRAPE

903005

12/24

900078 200x300 cm, 18x21 cm

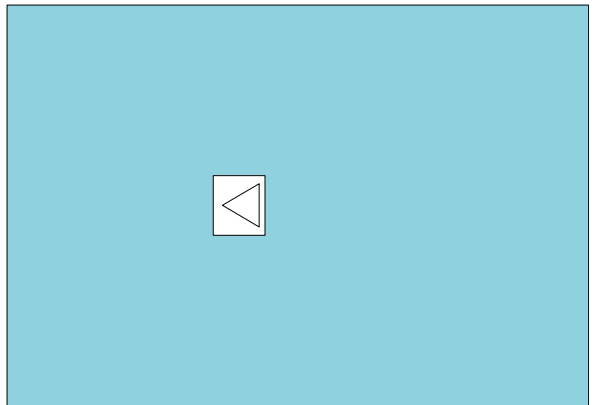

LAPAROSCOPY/LAPAROTOMY DRAPE

249

/13

9249 196/257x323 cm, reinforcement 46x91 cm, /18  
variable aperture 20x31 cm, wrapped

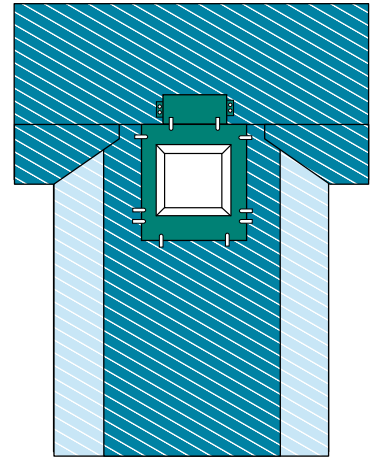

LAPAROTOMY DRAPE W/ POUCHES

297

/12

9297 196/257x323 cm, reinforcement 46x76 cm, /16  
variable aperture 8x31 cm, wrapped

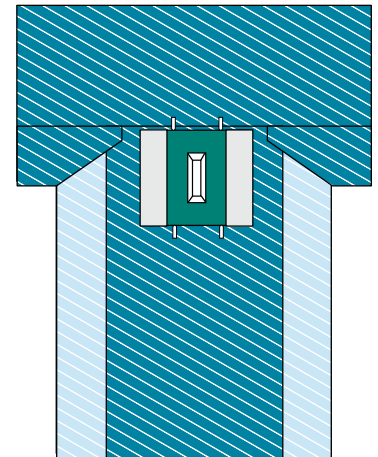

GENERAL ENDOSCOPY DRAPE W/  
OPEN POUCHES

696

/12

- 196/257x333 cm, reinforcement 46x84 cm,  
aperture 31x31 cm, wrapped

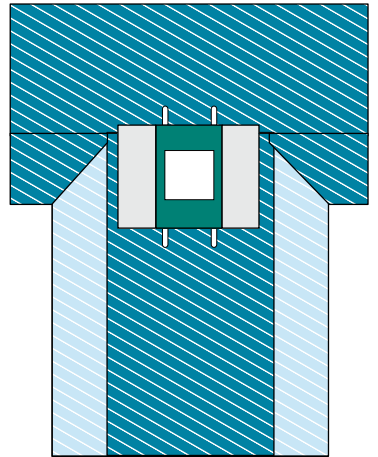

NEONATAL DRAPE

1202

/22

9907 168x241 cm, reinforcement 46x61 cm, /28  
aperture 8 cm, wrapped

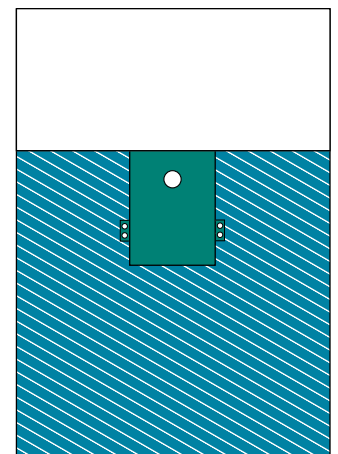

**PAEDIATRIC DRAPE**

**1204** /14

9833 196/257x320 cm, reinforcement 46x71 cm, /18  
aperture 11x17 cm, wrapped

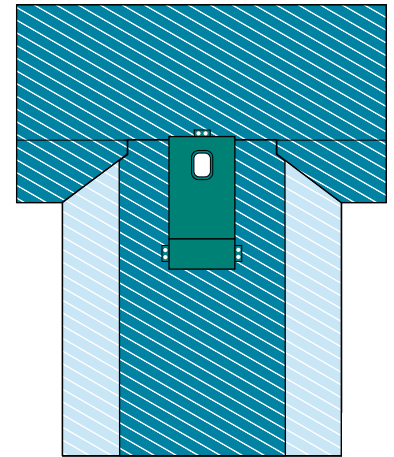

**BREAST/CHEST DRAPE**

**1216** /14

- 196/257x320 cm, reinforcement 71x91 cm, /14  
aperture 35x28 cm, wrapped

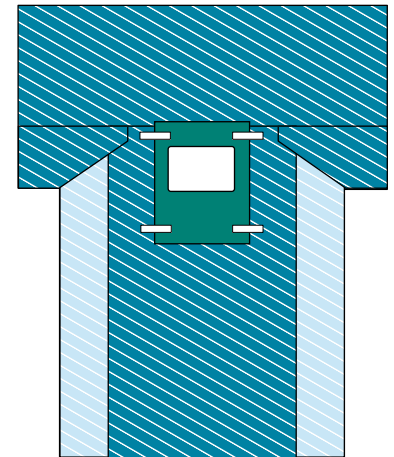

**LAPAROTOMY DRAPE**

**1246** /15

9446 196/257x323 cm, reinforcement 46x71 cm, /16  
incise area 23x36 cm, wrapped

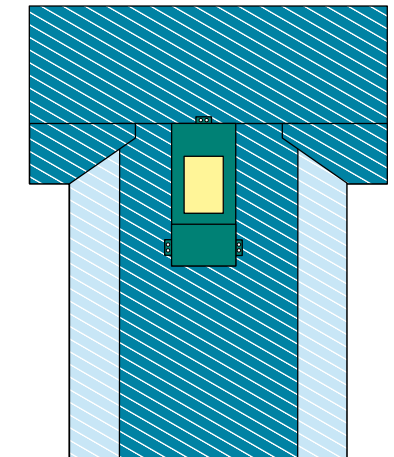

**LAPAROTOMY DRAPE**

**1290** /14

- 196/257x323 cm, reinforcement 46x71 cm, /14  
aperture 10x31 cm, wrapped

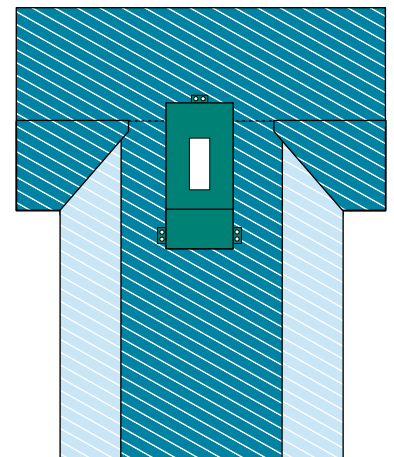

**LAPAROTOMY DRAPE**

**1293** /14

9693 196/257x323 cm, reinforcement 46x71 cm, /17

969330 variable aperture 8x31 cm, wrapped /120

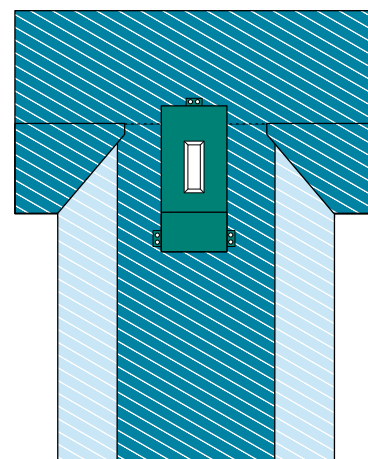

**PAEDIATRIC DRAPE**

**1294** /20

9903 196x254 cm, reinforcement 46x71 cm, /24

aperture 12x17 cm, wrapped

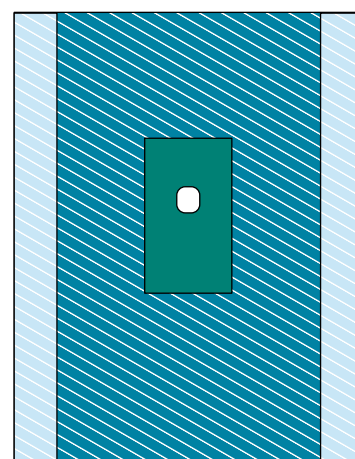

**PAEDIATRIC INCISE DRAPE**

**1299** /20

9699 196x254 cm, reinforcement 46x71 cm, /29

incise area 12x17 cm, wrapped

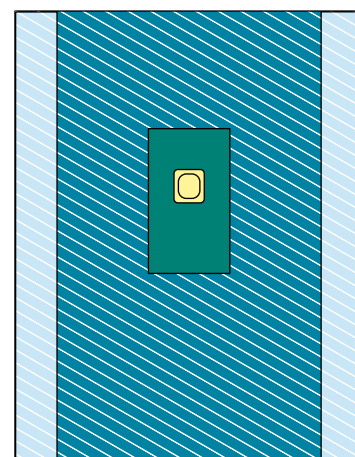

**ADHESIVE APERTURE DRAPE**

**84552160** /14

921102 208x300 cm, reinforcement 46x80 cm, /22

incise area 12.5x16.5 cm, wrapped

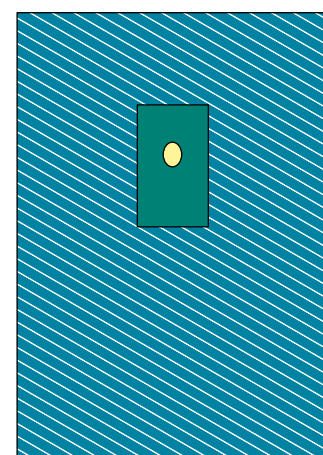



## **GYNAECOLOGY SETS AND DRAPES**

**GYNAECOLOGY SET**

**565710**

11/22

- 2 cellulose towel 19x25 cm
- 910598 2 adhesive towel 75x75 cm
- 911510 1 op-tape 9x49 cm
- 906109 2 leggings 75x120 cm
- 914080 1 table cover 150x190 cm, 75x190 cm absorbent

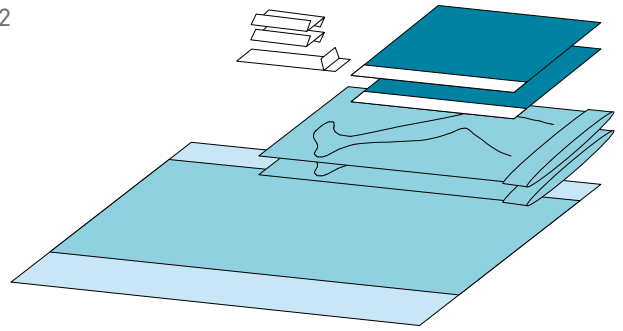

**GYN/CYSTOSCOPY SET**

**696110**

10/20

- 906109 2 leggings 75x120 cm
- 957961 1 aperture drape 75x175 cm, aperture 9x15 cm
- 914080 1 table cover 150x190 cm, 75x190 cm absorbent

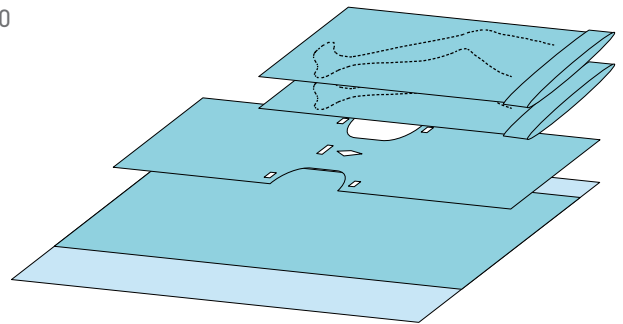

**LITHOTOMY SET**

**696450**

13/26

- 906109 2 leggings 75x120 cm
- 972890 1 under buttocks drape 75x100 cm
- 910184 1 op-sheet 90x150 cm
- 1 wrap 74x74 cm

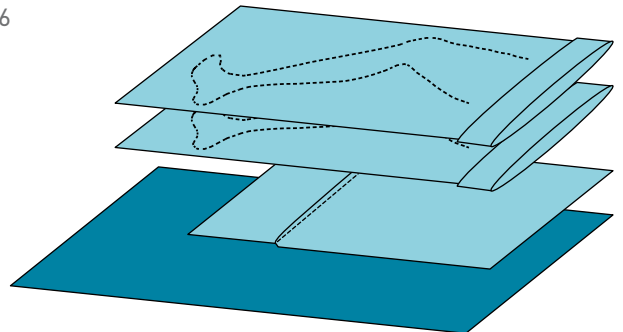

**GYN/LAPAROSCOPY SET**

**696500**

9/18

- 2 cellulose towel 19x25 cm
- 968005 1 utility drape 75x90 cm
- 906109 2 leggings 75x120 cm
- 946965 1 laparoscopy drape 150x130 cm, triangular aperture 26x20 cm
- 914080 1 table cover 150x190 cm, 75x190 cm absorbent

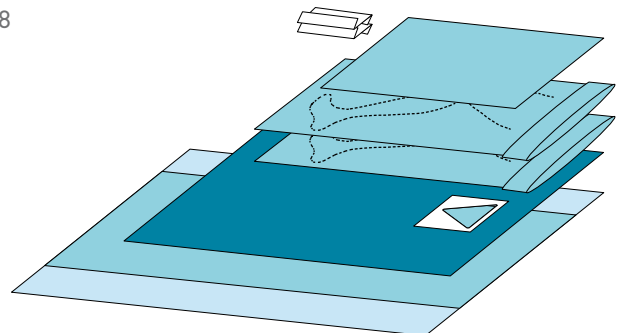

**GYN/LAPAROSCOPY SET**

**696600**

7/14

- 2 cellulose towel 19x25 cm
- 911510 1 op-tape 9x49 cm
- 910598 1 adhesive towel 75x75 cm
- 956966 1 laparoscopy drape w/leggings 250/270x310 cm, triangular aperture 26x20 cm, 7,5x13 cm
- 914080 1 table cover 150x190 cm, 75x190 cm absorbent

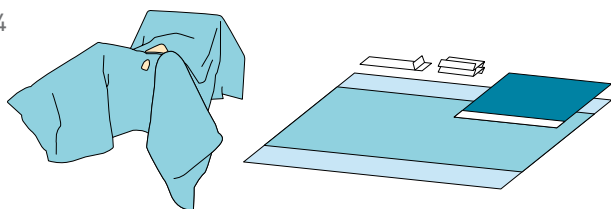

**GYNAECOLOGY SET**

**696700**

7/14

- 4 cellulose towel 19x25 cm
- 910519 2 op-towel 75x90 cm
- 947064 1 adhesive towel 50x50 cm
- 911510 2 op-tape 9x49 cm
- 987762 1 lithotomy drape w/leggings 150x200 cm
- 914080 1 table cover 150x190 cm, 75x190 cm absorbent

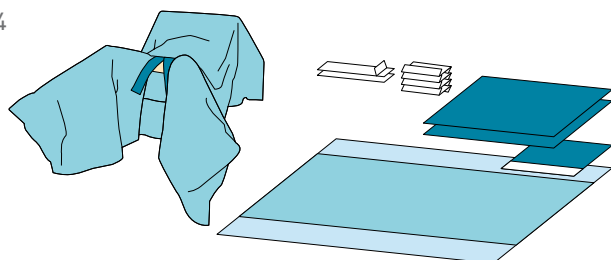

**GYNAECOLOGY SET**

**696810**

9/18

- 1 cellulose towel 19x25 cm
- 911510 1 op-tape 9x49 cm
- 972890 1 under buttocks drape 75x100 cm
- 947064 1 adhesive towel 50x50 cm
- 969681 1 gyn drape w/leggings 200/270x220 cm, aperture 9x13 cm
- 914080 1 table cover 150x190 cm, 75x190 cm absorbent

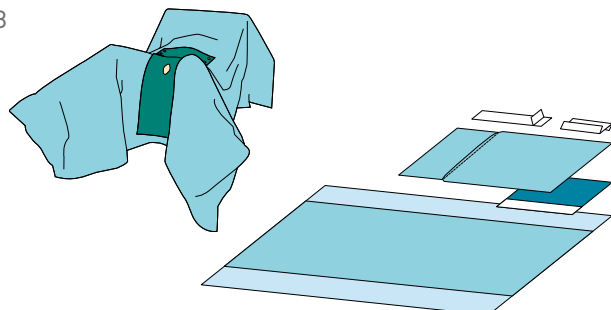

**GYNAECOLOGY SET**

**888112**

7/14

- 996106 1 mayo stand cover 79x145 cm, 65x85 cm absorbent
- 2 cellulose towel 19x25 cm
- 904762 1 tube holder 9x18 cm
- 988520 1 gyn drape 60x116 cm w/pouch, aperture 8x11 cm
- 965523 1 base drape w/leggings 200/270x215 cm
- 914080 1 table cover 150x190 cm, 75x190 cm absorbent

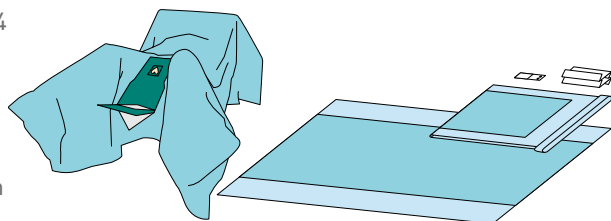

**GYNAECOLOGY SET**

**888113**

7/14

- 996106 1 mayo stand cover 79x145 cm,  
65x85 cm absorbent
- 2 cellulose towel 19x25 cm
- 904762 1 tube holder 9x18 cm
- 988521 1 gyn drape 60x116 cm, aperture 8x11 cm
- 965523 1 base drape w/leggings 200/270x215 cm
- 914080 1 table cover 150x190 cm, 75x190 cm absorbent

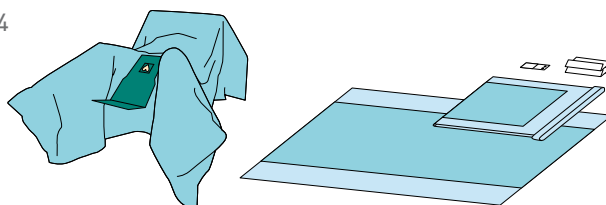

**GYNAECOLOGY SET**

**888212**

7/14

- 2 cellulose towel 19x25 cm
- 904762 1 tube holder 9x18 cm
- 988520 1 gyn drape 60x116 cm w/pouch, aperture 8x11 cm
- 965523 1 base drape w/leggings 200/270x215 cm
- 914080 1 table cover 150x190 cm, 75x190 cm absorbent

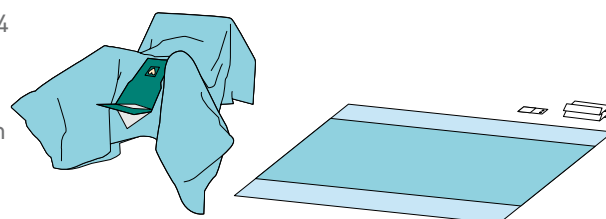

**GYN/CYSTOSCOPY SET**

**902496**

9/18

- 904745 1 utility drape 75x80 cm
- 906109 2 leggings 75x120 cm
- 904746 1 cystoscopy drape 75x175 cm, aperture 9x15 cm
- 914080 1 table cover 150x190 cm, 75x190 cm absorbent

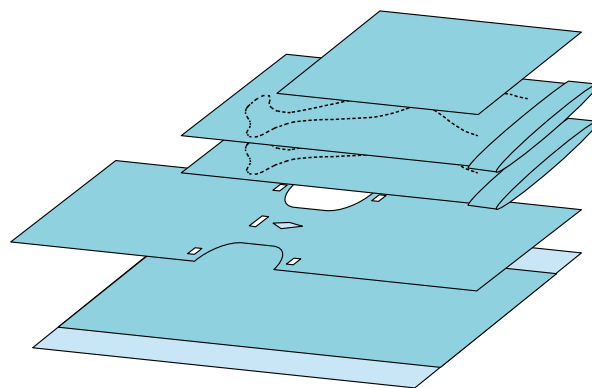

**GYN/LAPAROSCOPY SET**

**903020**

5/10

- 996106 1 mayo stand cover 79x145 cm,  
65x85 cm absorbent
- 4 cellulose towel 19x25 cm
- 911510 2 op-tape 9x49 cm
- 947064 1 adhesive towel 50x50 cm
- 969660 1 laparoscopy drape w/leggings 200x320 cm,  
apertures 25x20 cm and 6x15 cm
- 914080 1 table cover 150x190 cm, 75x190 cm absorbent

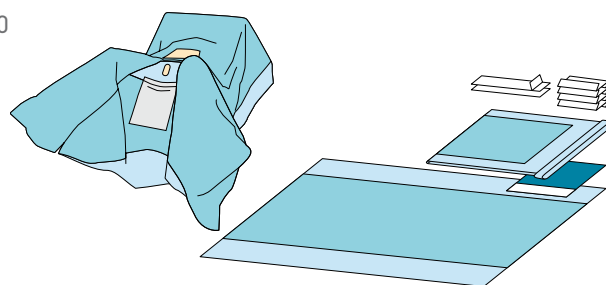



URO/GYNAECOLOGY SET

905020

5/10

- 996106 1 mayo stand cover 79x145 cm,  
65x85 cm absorbent
- 972890 1 under buttocks drape 75x100 cm
- 4 cellulose towel 19x25 cm
- 990520 1 uro/gynaecology drape 200/355x295 cm,  
aperture 17/8x28cm
- 914080 1 table cover 150x190 cm, 75x190 cm absorbent

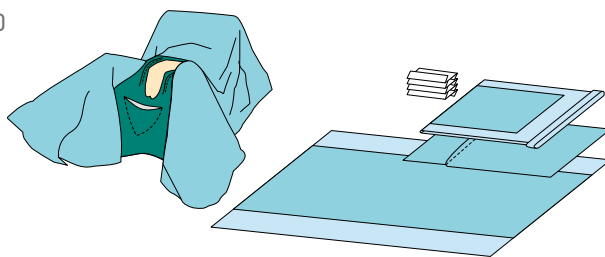

GYNAECOLOGY SET

925982

7/14

- 3 cellulose towel 19x25 cm
- 1 utility drape 75x120 cm
- 906109 2 leggings 75x120 cm
- 900068 1 gyn-split sheet 140x150 cm
- 900069 1 abdominal drape 115x150 cm
- 1 table cover 140x150 cm, 75x140 cm absorbent

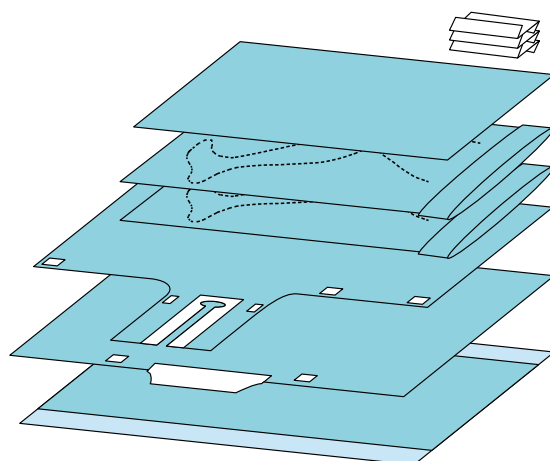

GYNAECOLOGY SET

925984

5/10

- 824098 1 tube holder velcro 2,5x30 cm
- 996106 1 mayo stand cover 79x145 cm,  
65x85 cm absorbent
- 4 cellulose towel 19x25 cm
- 972890 1 under buttocks drape 75x100 cm
- 950022 1 gyn-drape 200/270x280 cm, aperture 8x11 cm
- 914080 1 table cover 150x190 cm, 75x190 cm absorbent

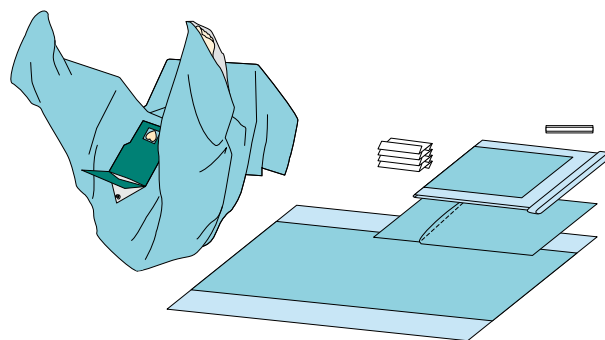

**GYNAECOLOGY SET I**

**251** /10

- 9629 1 under buttocks drape 91x117 cm, 45x56 cm absorbent
- 9354 1 adhesive utility drape 66x37 cm
- 9855 2 XL lithotomy leggings 79x152 cm
- 1 patient drape 91x145 cm
- 9660 1 table cover 140x215 cm, 66x215 cm absorbent

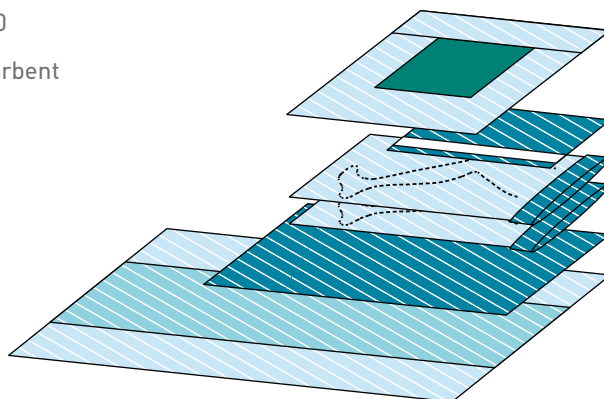

**GYNAECOLOGY SET**

**257** /8

- 750108 1 surgical gown XL
- 1 under buttocks drape 61x86 cm
- 9855 2 XL lithotomy leggings 79x152 cm
- 9757 1 gynaecology drape 79/146x221 cm, aperture 9x18 cm
- 9660 1 table cover 140x215 cm, 66x215 cm absorbent

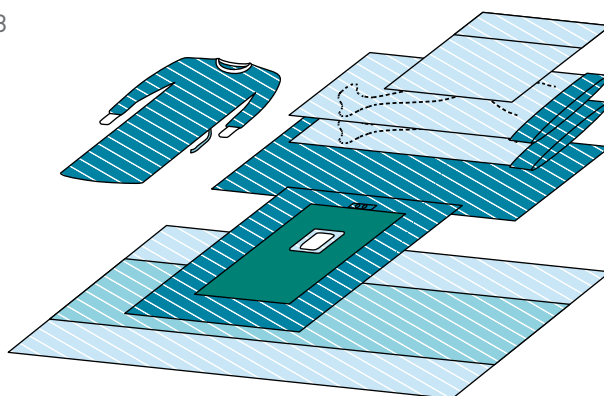

**LAPAROSCOPY SET I**

**258** /10

- 1 under buttocks drape 61x86 cm
- 9354 1 adhesive utility drape 66x37 cm
- 9855 2 XL lithotomy leggings 79x152 cm
- 9652 1 gynaecology drape 79/254x244 cm, apertures 9x18 cm, 6x15 cm
- 9660 1 table cover 140x215 cm, 66x215 cm absorbent

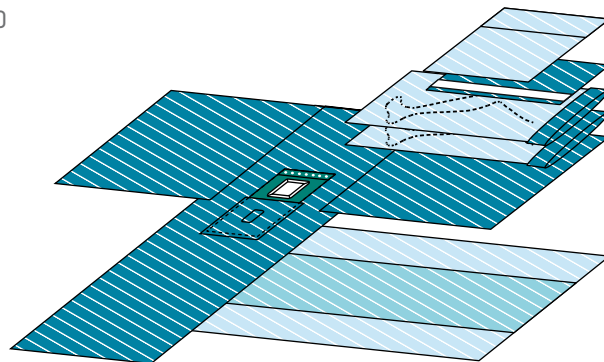

**LITHOTOMY SET I**

**1250** /10

- 9629 1 under buttocks drape 91x117 cm, 45x56 cm absorbent
- 9354 1 adhesive utility drape 66x37 cm
- 9755 2 lithotomy leggings 69x122 cm
- 9525 1 patient drape 104x145 cm
- 9660 1 table cover 140x215 cm, 66x215 cm absorbent

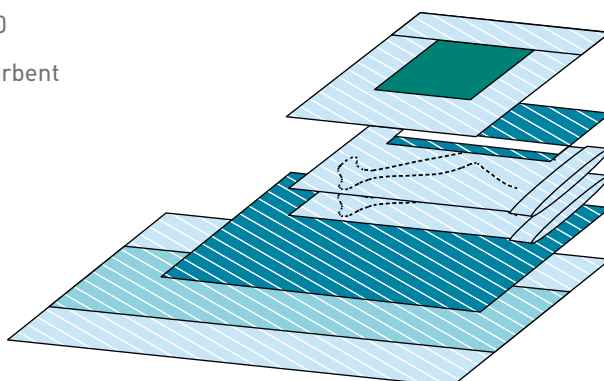

**LITHOTOMY SET II**

1251

/12

- 1 under buttocks drape 61x86 cm
- 9354 1 adhesive utility drape 66x37 cm
- 9507 1 lithotomy gynaecology drape 183/265x203 cm, aperture 6x17 cm
- 9660 1 table cover 140x215 cm, 66x215 cm absorbent

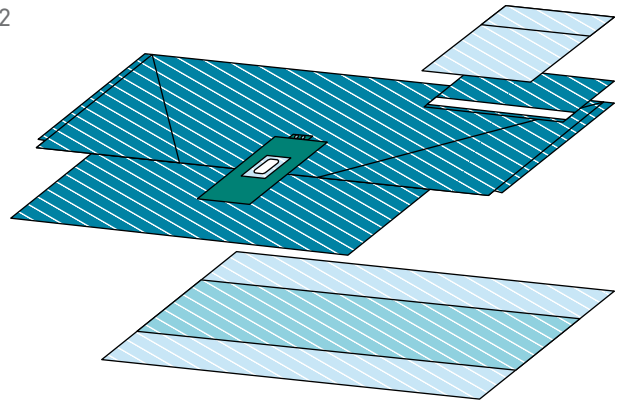

**LAPAROSCOPY SET II**

1259

/5

- 750101 1 surgical gown L + 1 hand towel 50x50 cm, wrapped
- 750108 1 surgical gown XL
- 9544 1 mayo stand cover 58x137 cm, 45x56 cm absorbent
- 9755 2 lithotomy leggings 69x122 cm
- 9354 1 adhesive utility drape 66x37 cm
- 1 under buttocks drape 61x86 cm
- 9652 1 gynaecology drape 79/254x244 cm, apertures 9x18 cm, 6x15 cm
- 9370 1 table cover reinforced 127x229 cm, 61x152 cm absorbent

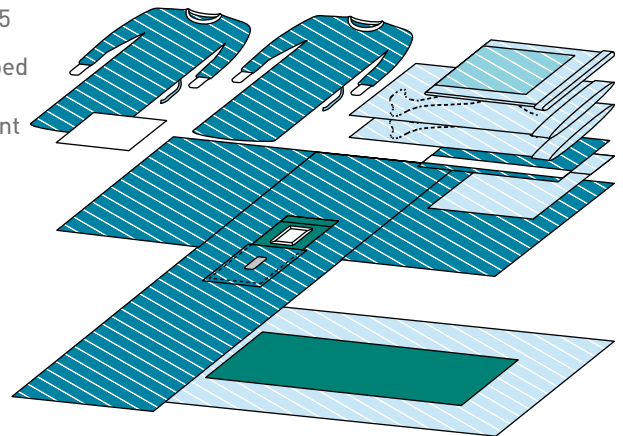

**OB SET I**

2350

/8

- 9630 1 set-up cover 112x191cm
- 9629 1 under buttocks drape 91x117 cm, 45x56 cm absorbent
- 2 cellulose towel 50x50 cm
- 9525 1 patient drape 104x145 cm
- 10 sponges 10x10 cm
- 1 vaginal sponge
- 80008022 1 table cover 140x180 cm, 66x180 cm absorbent

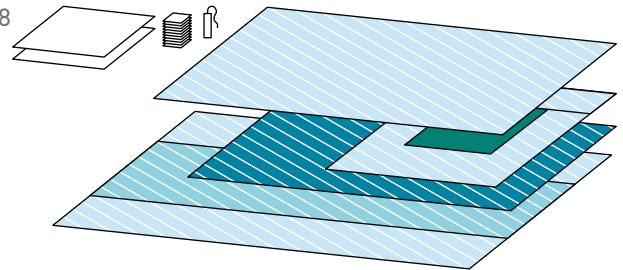

**LITHOTOMY SET II**

**80011691 /11**

- 9629 1 under buttocks drape 91x117 cm, 45x56 cm absorbent
- 9755 2 lithotomy leggings 69x122 cm
- 8031 1 lithotomy drape 79/146x166 cm, aperture 10 cm
- 1 wrap 86x86 cm

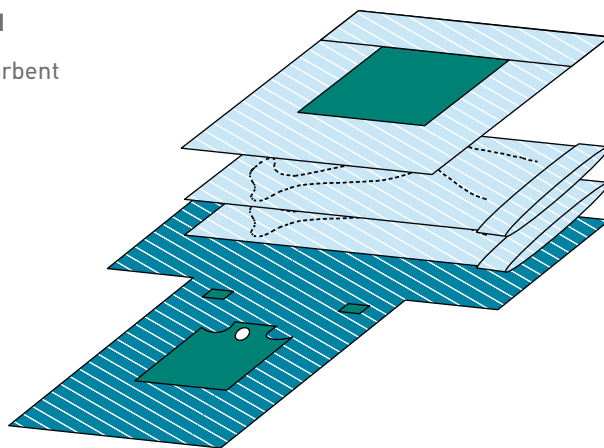

**ABDOMINAL/GYNAECOLOGY SET**

**80011731 /5**

- 8081 1 op-tape 9x50 cm
- 8046 1 mayo stand cover reinforced 79x145 cm, 61x85 cm absorbent
- 8008055 1 abdominal gynaecology drape 203/257x315 cm, aperture 30x16 cm
- 80008022 1 table cover 140x180 cm, 66x180 cm absorbent

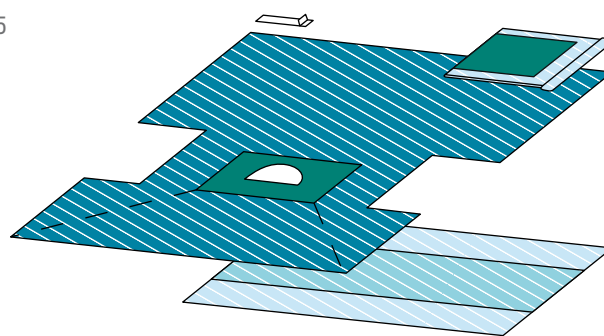

**D+C SET**

**80974401 /18**

- 9755 2 lithotomy leggings 69x122 cm
- 1 lithotomy drape 75x160 cm, aperture 10 cm
- 1 wrap 86x86 cm

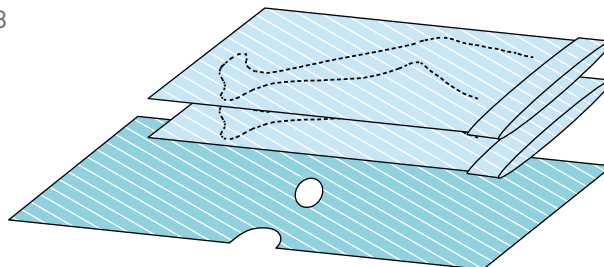

**LITHOTOMY SET II**

**80974411 /8**

- 9629 1 under buttocks drape 91x117 cm, 45x56 cm absorbent
- 9755 2 lithotomy leggings 69x122 cm
- 8031 1 lithotomy drape 79/146x166 cm, aperture 10 cm
- 80008022 1 table cover 140x180 cm, 66x180 cm absorbent

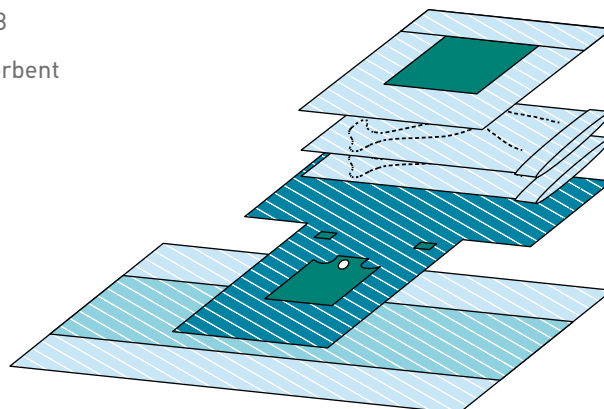

**MAJOR LITHOTOMY SET**

84511210

/7

- 2 op-tape 8x45 cm
- 1 table cover 140x160 cm, 66x160 cm absorbent
- 922803 2 adhesive op-towel 90x79 cm
- 9755 2 lithotomy leggings 69x122 cm
- 9629 1 under buttocks drape 91x117 cm, 45x56 cm absorbent
- 8008075 2 adhesive op-towel 115x92 cm, reinforcement 30x90 cm
- 1 adhesive op-sheet 240x183 cm, reinforcement 30x90 cm
- 80008022 1 table cover 140x180 cm, 66x180 cm absorbent

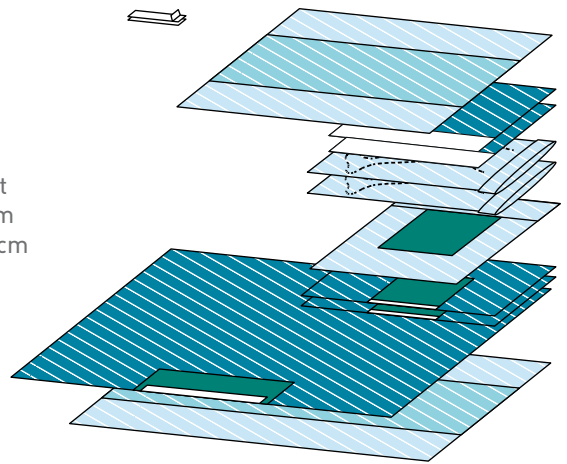

**D + C SET**

84511271

/20

- 2 op-tape 8x45 cm
- 9755 2 lithotomy leggings 69x122 cm
- 1 aperture drape 75x200 cm, aperture 8x19 cm
- 1 table cover 140x160 cm, 66x160 cm absorbent

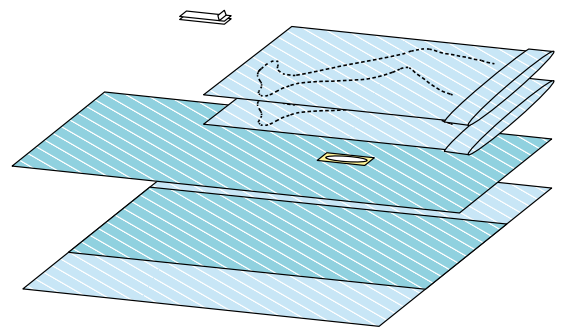

LAPAROSCOPY/LAVH DRAPE

253

/8

9254 183/257x231 cm, apertures 15x20 cm,  
6x15 cm, wrapped

/9

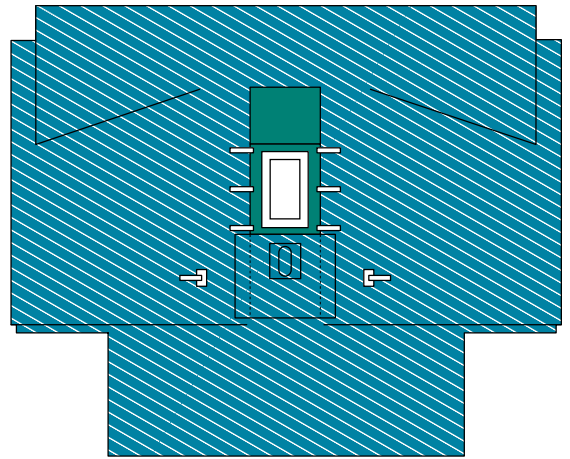

LITHOTOMY DRAPE

8032

/45

8031 79/146x166 cm, aperture 10 cm, wrapped

/50

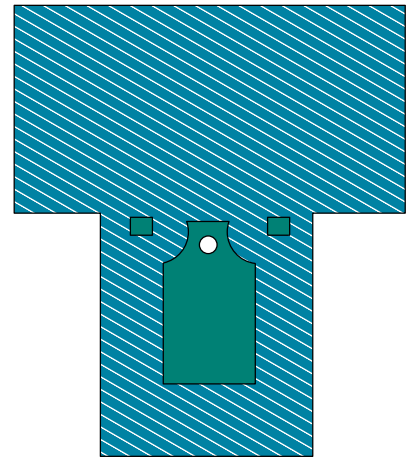



## NEURO SETS AND DRAPES

## CRANIOTOMY SET

888142

5/10

- 996106 1 mayo stand cover 79x145 cm, 65x85 cm absorbent
- 2 cellulose towel 19x25 cm
- 911510 1 op-tape 9x49 cm
- 947064 4 adhesive towel 50x50 cm
- 965524 1 craniotomy drape 230x290 cm, incise area 30x20 cm
- 914080 1 table cover 150x190 cm, 75x190 cm absorbent

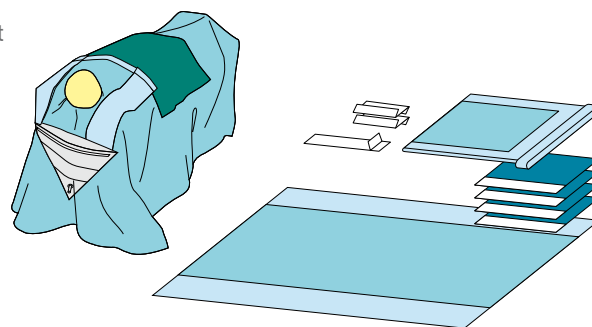

## CRANIOTOMY SET

888242

5/10

- 2 cellulose towel 19x25 cm
- 911510 1 op-tape 9x49 cm
- 947064 4 adhesive towel 50x50 cm
- 965524 1 craniotomy drape 230x290 cm, incise area 30x20 cm
- 914080 1 table cover 150x190 cm, 75x190 cm absorbent

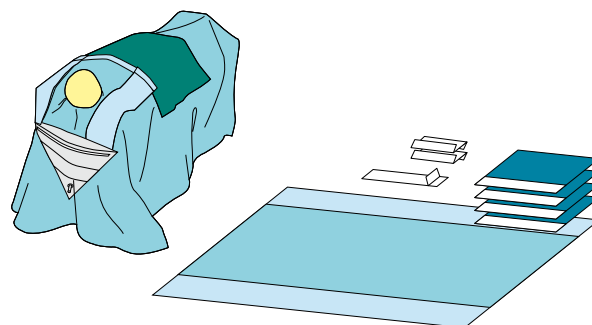



**CRANIOTOMY DRAPE**

**291**

/10

9791 279x218 cm, reinforcement 71x86 cm,  
incise area 30x20 cm, wrapped

/30

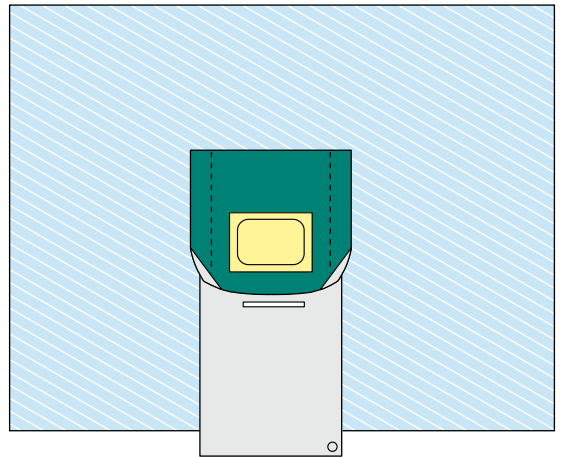

**CRANIOTOMY DRAPE**

**316**

/9

9316 256x325 cm, reinforcement 71x86 cm,  
incise area 30x20 cm, wrapped

/10

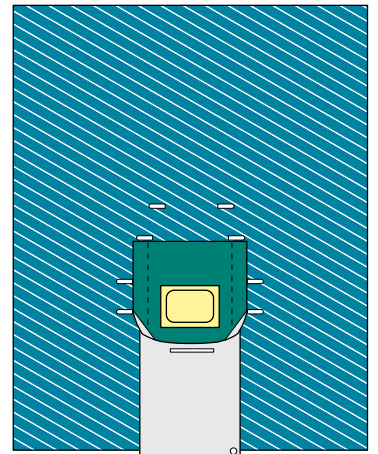

**CRANIOTOMY DRAPE**

**80974470**

/5

- 254x360 cm, aperture 32x32 cm, split 85 cm, wrapped

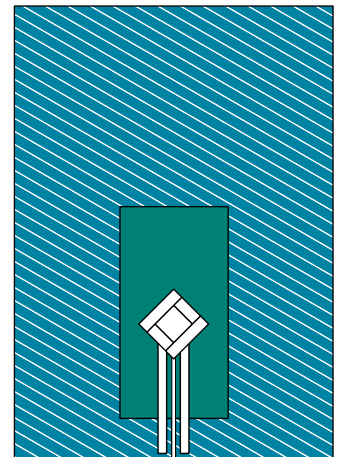

**CRANIOTOMY DRAPE**

**84551030**

/15

920703 220x300 cm, reinforcement 71x91 cm,  
incise area 20x30 cm, wrapped

/14

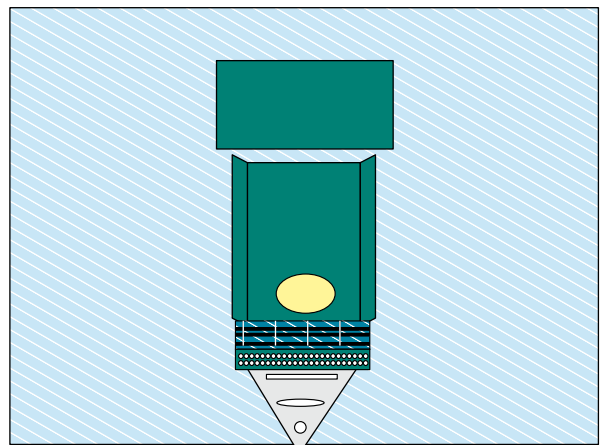



## **OBSTETRIC SETS AND DRAPES**

**SECTIO SET**

**694110**

5/10

- 4 cellulose towel 19x25 cm
- 911510 1 op-tape 9x49 cm
- 910433 1 baby wrap 90x120 cm
- 969674 1 sectio drape 175/250x300 cm, incise area 38x32 cm
- 914080 1 table cover 150x190 cm, 75x190 cm absorbent

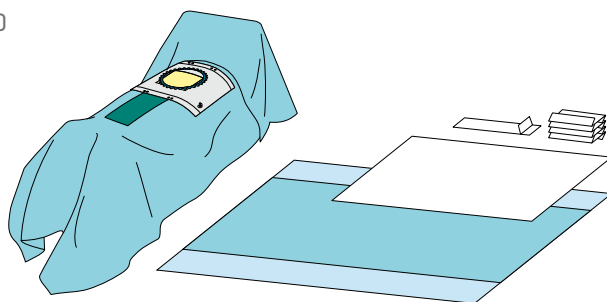

**SECTIO SET**

**694135**

4/8

- 996106 1 mayo stand cover 79x145 cm, 65x85 cm absorbent
- 4 cellulose towel 19x25 cm
- 911510 1 op-tape 9x49 cm
- 910433 1 baby wrap 90x120 cm
- 969673 1 sectio drape 175/250x300 cm, incise area 38x32 cm, aperture 18x16 cm
- 914080 1 table cover 150x190 cm, 75x190 cm absorbent

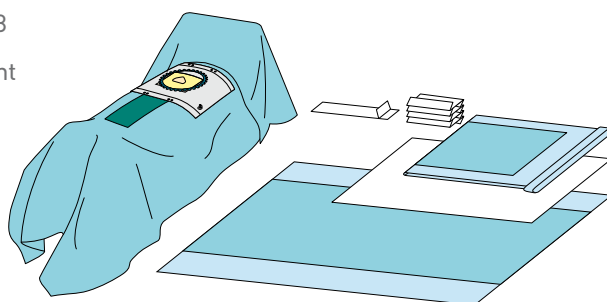

**SECTIO SET**

**694140**

5/10

- 4 cellulose towel 19x25 cm
- 911510 1 op-tape 9x49 cm
- 910433 1 baby wrap 90x120 cm
- 969673 1 sectio drape 175/250x300 cm, incise area 38x32 cm, aperture 18x16 cm
- 914080 1 table cover 150x190 cm, 75x190 cm absorbent

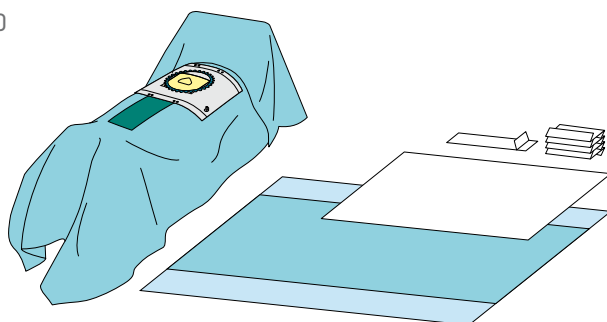

**SECTIO SET**

**694145**

4/8

- 996106 1 mayo stand cover 79x145 cm, 65x85 cm absorbent
- 4 cellulose towel 19x25 cm
- 911510 1 op-tape 9x49 cm
- 910433 1 baby wrap 90x120 cm
- 969675 1 sectio drape 175/270x295 cm, incise area 38x32 cm, aperture 18x16 cm
- 914080 1 table cover 150x190 cm, 75x190 cm absorbent

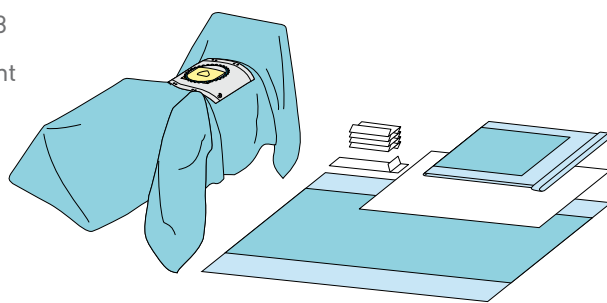

**PFANNENSTIEL SET**

**694500**

7/14

- 996106 1 mayo stand cover 79x145 cm, 65x85 cm absorbent
- 4 cellulose towel 19x25 cm
- 911510 1 op-tape 9x49 cm
- 976945 1 pfannenstiel drape 200/270x335 cm, aperture 30x16 cm
- 914080 1 table cover 150x190 cm, 75x190 cm absorbent

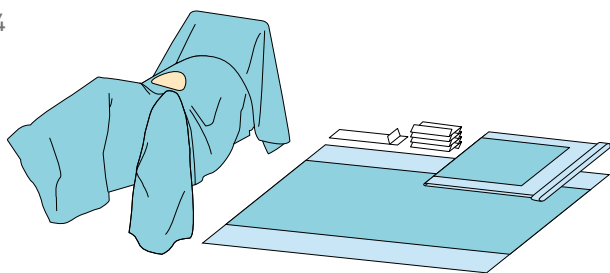

**DELIVERY SET**

**695000**

/12

- 911510 1 op-tape 9x49 cm
- 2 cellulose towel 19x25 cm
- 9229 1 under buttocks drape 86x112 cm
- 906109 2 leggings 75x120 cm
- 1 baby wrap 100x100 cm
- 968005 1 utility drape 75x90 cm
- 910198 1 adhesive towel 75x75 cm
- 914080 1 table cover 150x190 cm, 75x190 cm absorbent

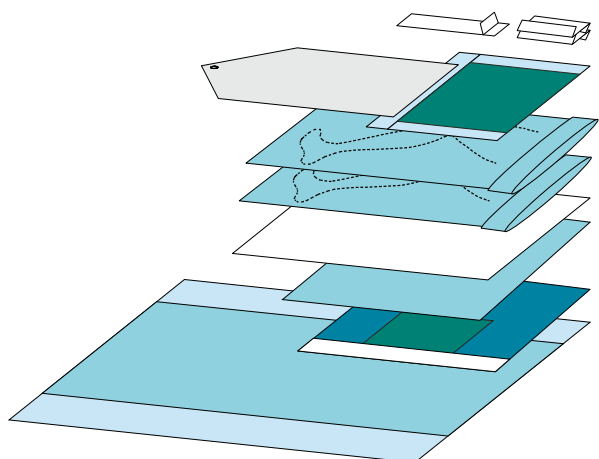

**SECTIO SET**

**903328**

4/8

- 4 cellulose towel 19x25 cm
- 911510 1 op-tape 9x49 cm
- 910433 1 baby wrap 90x120 cm
- 904734 1 sectio drape 230x330 cm, incise area 38x32 cm
- 914080 1 table cover 150x190 cm, 75x190 cm absorbent

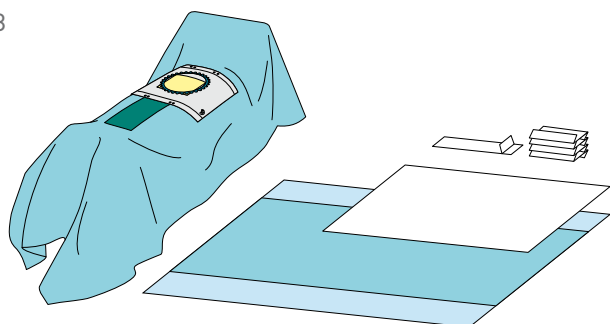

**SECTIO SET**

**903355**

4/8

- 996106 1 mayo stand cover 79x145 cm, 65x85 cm absorbent
- 4 cellulose towel 19x25 cm
- 911510 1 op-tape 9x49 cm
- 947064 1 adhesive towel 50x50 cm
- 910433 1 baby wrap 90x120 cm
- 904743 1 sectio drape 175/250x300 cm folded length wise, incise area 38x32 cm
- 914080 1 table cover 150x190 cm, 75x190 cm absorbent

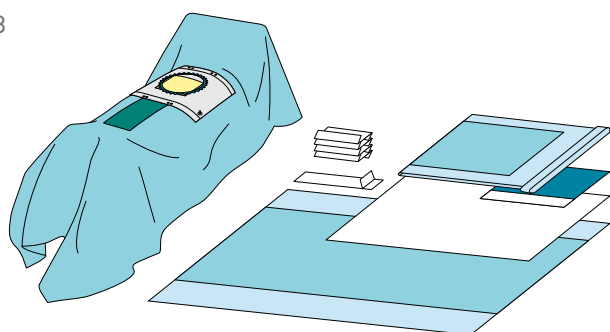

**SECTIO SET**

903440

2/4

- 760102 1 reinforced surgical gown LL + hand towel 45x33 cm
- 996106 1 mayo stand cover 79x145 cm, 65x85 cm absorbent
- 4 cellulose towel 19x25 cm
- 911510 1 op-tape 9x49 cm
- 910433 1 baby wrap 90x120 cm
- 969674 1 sectio drape 175/250x300 cm, incise area 38x32 cm
- 760106 1 reinforced surgical gown XXL + hand towel 45x33 cm
- 760102 1 reinforced surgical gown LL + hand towel 45x33 cm
- 914080 1 table cover 150x190 cm, 75x190 cm absorbent

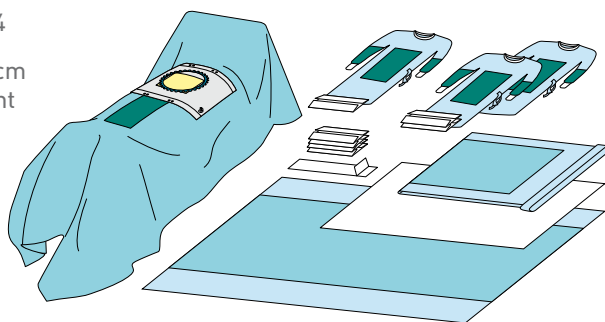

**DELIVERY SET**

904383

/14

- 1 utility drape 75x120 cm
- 1 bed pad 55x80 cm
- 304998 1 absorbent towel 56x80 cm
- 6 cellulose towel 18x26 cm
- 1 bed pad 55x60 cm
- 1 table cover 100x150 cm, 75x150 cm absorbent

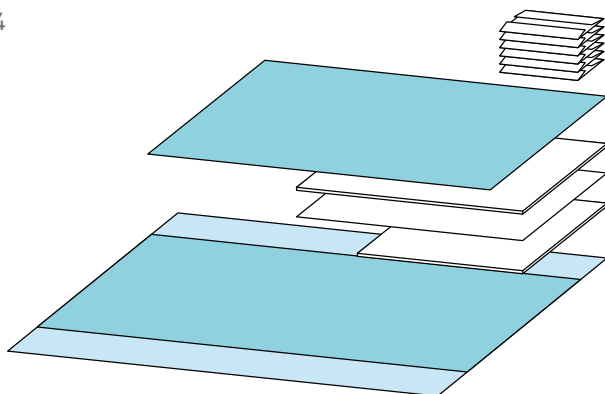

**DELIVERY SET**

914341

/11

- 304998 2 absorbent towel 56x80 cm
- 1 bed pad 55x80 cm
- 6 cellulose towel 18x26 cm
- 904713 2 utility drape 50x60 cm
- 1 vaginal tampon
- 20 nonwoven compress 10x10 cm
- 1 table cover 100x150 cm, 75x150 cm absorbent

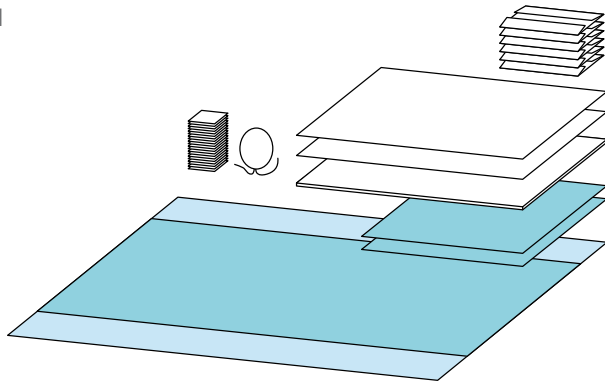

**DELIVERY SET II**

1235

/4

- 9630 1 SET-up cover 112x191cm
- 1 handtowel 50x50 cm
- 740101 1 tie-back surgical gown L
- 9629 1 under-buttocks drape 91x117 cm, 45x56 cm absorbent
- 9755 2 lithotomy leggings 69x122 cm
- 1 patient drape 79x146 cm, reinforcement 30x46 cm
- 10 swab 10x10 cm
- 1 vaginal sponge
- 1 bulb syringe 59 ml
- 2 sanitary towel
- 1 cord clamp 6 cm
- 1 placenta basin
- 9534 1 baby blanket 77x77 cm
- 9845 1 table cover 140x180 cm, 66x180 cm absorbent

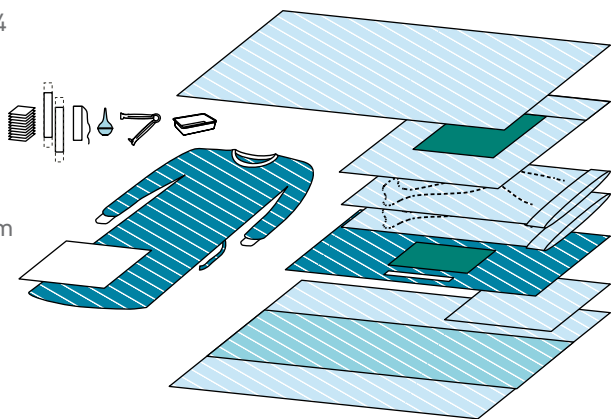

**C-SECTION SET III**

2330

/4

- 9544 1 mayo stand cover 58x137 cm, 45x56 cm absorbent
- 1 suture bag 16.5x28.5 cm
- 1 bulb syringe 59 ml
- 1 sanitary towel
- 1 cord clamp 6 cm
- 1 placenta basin
- 9239 1 c-section drape 196/257x325 cm, pouch 77x71 cm, incise area 38x30 cm, aperture 20x15 cm
- 9534 1 baby blanket 77x77 cm
- 930324 1 table cover reinforced 140x216 cm, 61x152 cm absorbent

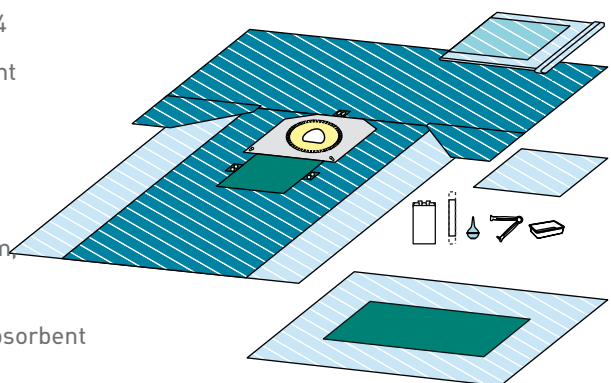

**C-SECTION SET**

84511392

/8

- 8046 1 mayo stand cover reinforced 79x145 cm, Pad 61x85 cm
- 9239 1 c-section drape 196/257x325 cm, pouch 77x71 cm, incise area 38x30 cm, aperture 20x15 cm
- 9534 1 baby blanket 77x77 cm
- 80008022 1 table cover 140x180 cm, 66x180 cm absorbent

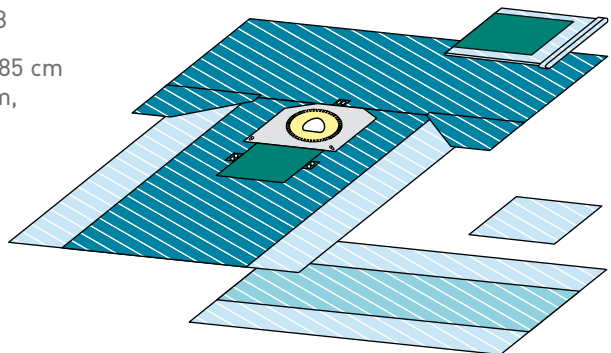

**DELIVERY SET**

84511571

/30

- 9629 1 under-buttocks drape 91x117 cm, 45x56 cm absorbent
- 9534 1 baby blanket 77x77 cm
- 922000 1 table cover 140x140 cm, 66x140 cm absorbent

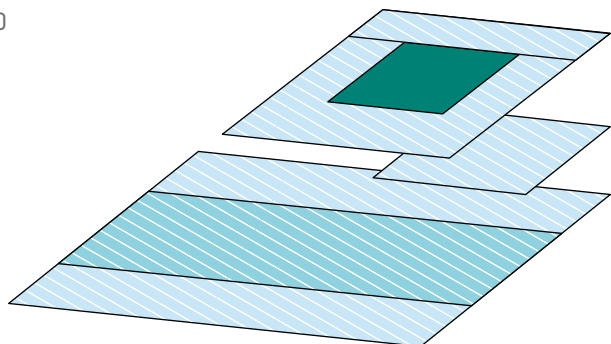

**C-SECTION SET****84512392**

/8

- 9534 1 baby blanket 77x77 cm  
80008022 1 table cover 140x180 cm, 66x180 cm absorbent  
9239 1 c-section drape 196/257x325 cm, pouch 77x71 cm,  
incise area 38x30 cm, aperture 20x15 cm  
80008022 1 table cover 140x180 cm, 66x180 cm absorbent

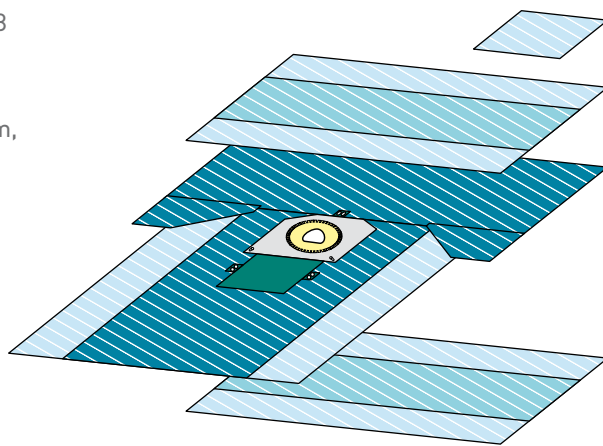

C-SECTION DRAPE

231

/11  
/15

9331 196/257x325 cm, pouch 77x71 cm,  
incise area 38x30 cm , wrapped

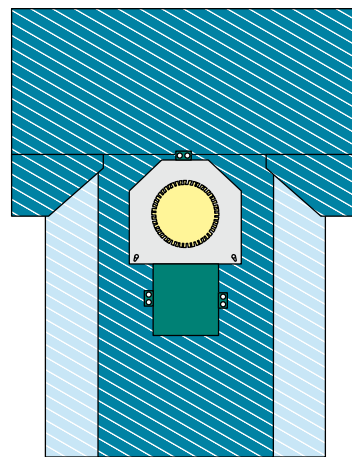

C-SECTION DRAPE

2390

/11  
/15

9239 196/257x325 cm, pouch 77x71 cm,  
incise area 38x30 cm, aperture 20x15 cm, wrapped

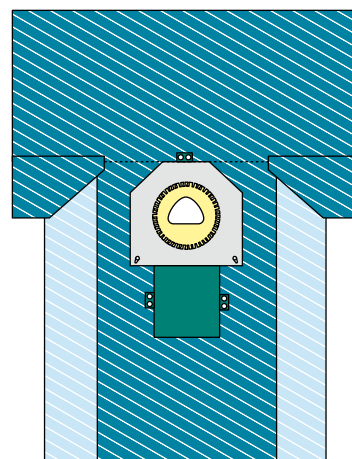

BABY BLANKET

84541251

/30  
/140

9534 77x77 cm, wrapped

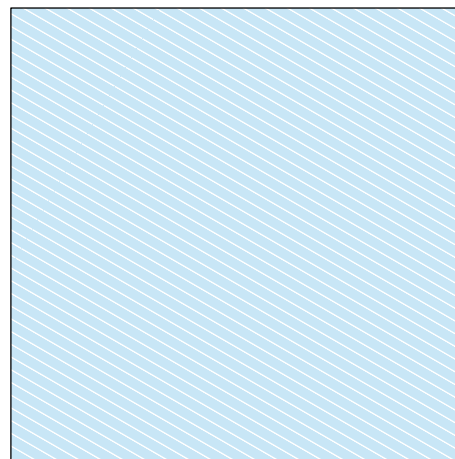





## OPHTHALMIC SETS AND DRAPES

**OPHTHALMIC SET**

**695400**

11/22

- 1 cellulose towel 19x25 cm
- 959540 1 ophthalmic drape 150x300 cm w/pouches, incise area 8x10 cm
- 914080 1 table cover 150x190 cm, 75x190 cm absorbent

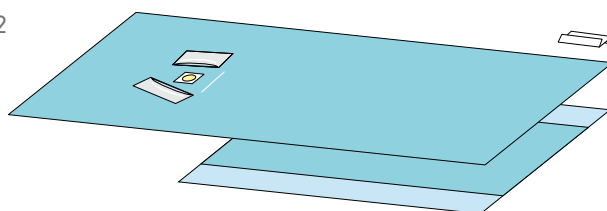

**OPHTHALMIC SET**

**903163**

16/32

- 1 cellulose towel 19x25 cm
- 900056 1 ophthalmic drape 140x150 cm w/pouch, incise area 8x10 cm, aperture 3,5x6,5 cm
- 1 table cover 150x140 cm, 75x140 cm absorbent

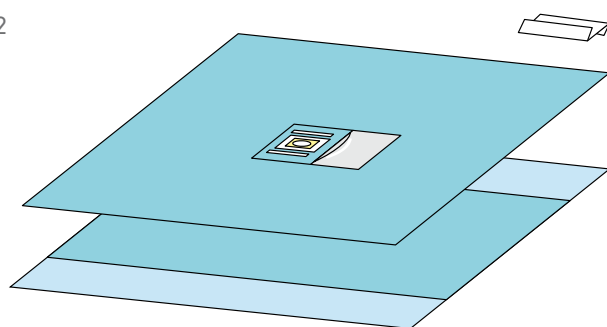

**OPHTHALMIC SET**

**903165**

10/20

- 1 cellulose towel 19x25 cm
- 900058 1 ophthalmic drape 150x300 cm w/pouches, incise area 8x10 cm aperture 3,5x6,5 cm
- 914080 1 table cover 150x190 cm, 75x190 cm absorbent

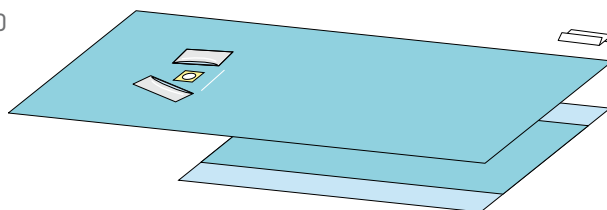

**OPHTHALMIC SET**

**903167**

16/32

- 1 cellulose towel 19x25 cm
- 900057 1 ophthalmic drape 140x150 cm w/pouch, incise area 8x10 cm
- 1 table cover 150x140 cm, 75x140 cm absorbent

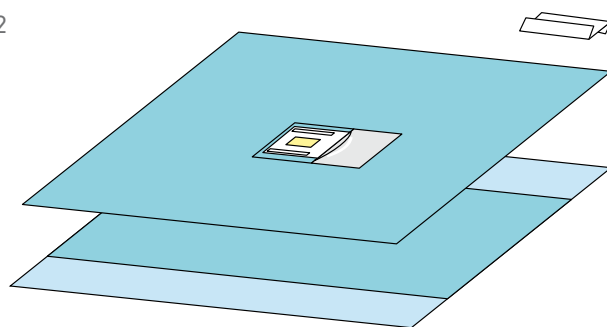

**OPHTHALMIC SET**

**903286**

16/32

- 1 cellulose towel 19x25 cm
- 1 incise film 10x12 cm
- 900031 1 ophthalmic drape 150x180 cm w/pouches, aperture 5x7 cm
- 1 table cover 150x140 cm, 75x140 cm absorbent

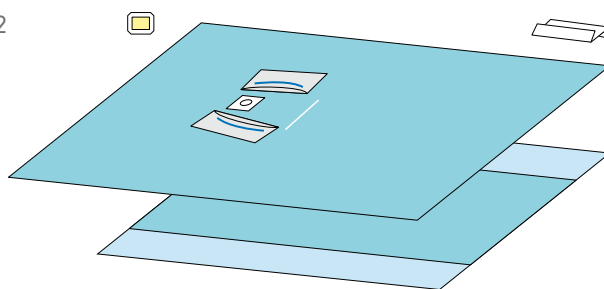

**OPHTHALMIC SET**

**915322**

16/32

- 900083 1 adhesive aperture drape 150x180 cm, aperture 5x7 cm
- 1 table cover 150x140 cm, 75x140 cm absorbent

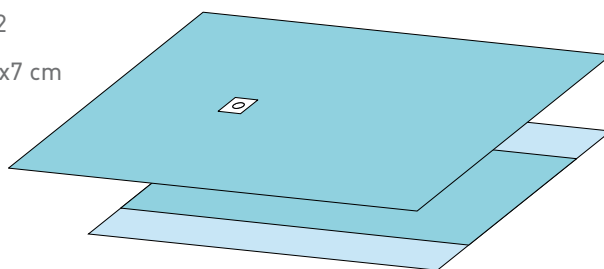

OPHTHALMIC SET

8000504

/16

- 1 eyelid drape 41x41 cm, incise area 13x13cm
- 1 eye wick 0.3x20 cm
- 9318 1 ophthalmic drainage bag 27x34 cm
- 920204 1 ophthalmic drape 130x183 cm, incise area 12.5x10 cm, aperture 6x4 cm
- wrap 107x107cm

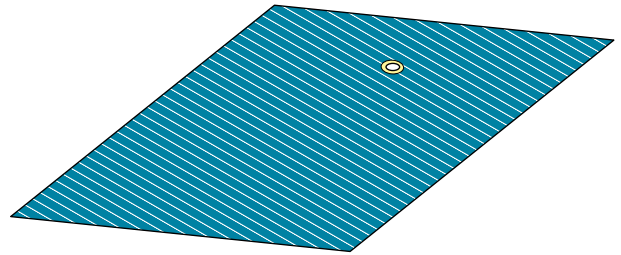
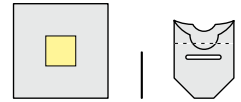

OPHTHALMIC SET

8000511

/7

- 750108 1 surgical gown XL + 2 Hand Towel 50x50 cm, wrapped
- 922550 2 arm support cover 35x73 cm
- 9544 1 mayo stand cover 58x137 cm, 45x56 cm absorbent
- 3 cellulose towel 50x50 cm
- 1 eye wick 0.3x20 cm
- 928004 1 ophthalmic drape w/pouch 140x146cm, incise area 9x8 cm
- 750114 1 surgical gown XXLL
- 1 table cover 140x140 cm, 66x140 cm absorbent

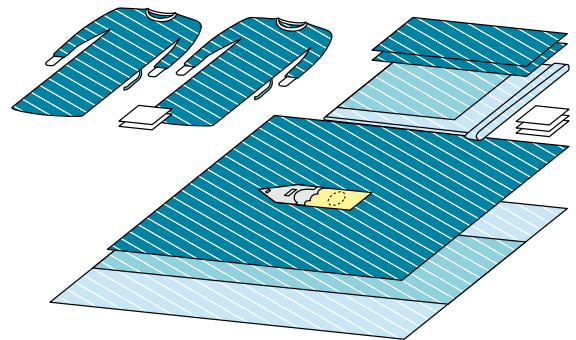

OPHTHALMIC SET

84511070

/12

- 10 swabs 5x5 cm
- 1 eye wick 0.3x20 cm
- 1 ophthalmic drainage bag 26x33 cm
- 925304 1 ophthalmic drape 146x275 cm, incise area 12.5x12.5 cm, aperture 5x3 cm
- 1 table cover 140x160 cm, 66x160 cm absorbent

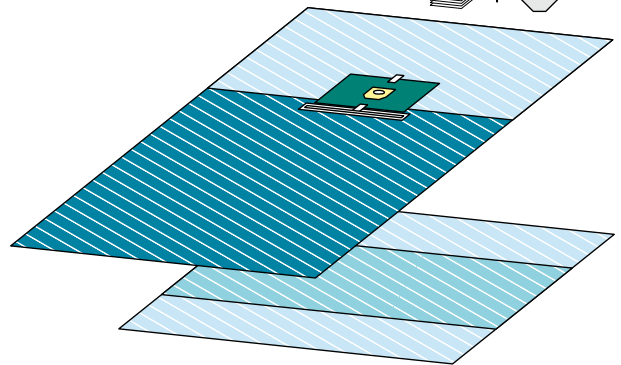

OPHTHALMIC SET APERTURED

84511451

/20

- 1 eye wick 0.3x20 cm
- 1 ophthalmic drape 155x146 cm incise area 9.5x8 cm, aperture 5x3 cm
- 1 table cover 140x160 cm, 66x160 cm absorbent

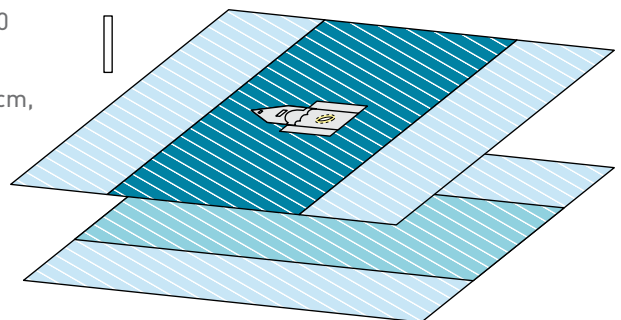

**OPHTHALMIC SET**

**84511461**

/20

- 1 eye wick 0.3x20 cm
- 928007 1 ophthalmic drape 155x146 cm, incise area 9.5x8cm
- 1 table cover 140x160 cm, 66x160 cm absorbent

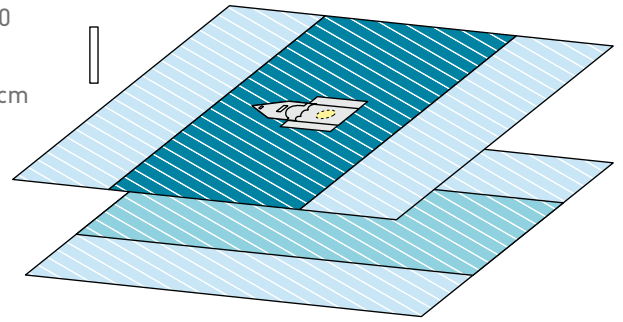

OPHTHALMIC DRAPE W/ POUCHES

824400

16/32

978244 150x165 cm, aperture 8 cm, separate incise film 15x20cm

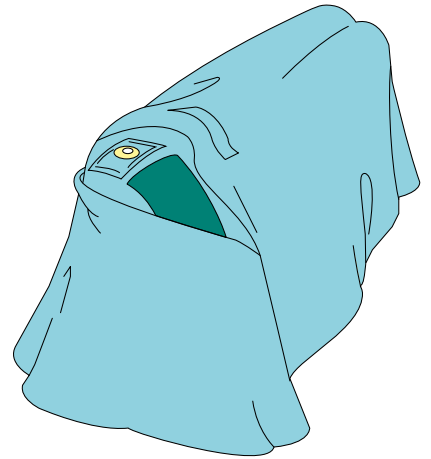

OPHTHALMIC DRAPE

831600

40/80

815302 45x45 cm w/ pouch, aperture 6 cm

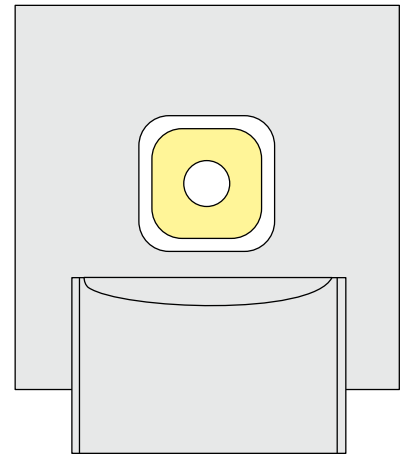

**OPHTHALMIC DRAPE**

**1213**

/24

9513 145x295 cm, incise area 10x10cm,  
aperture 6cm, wrapped

/28

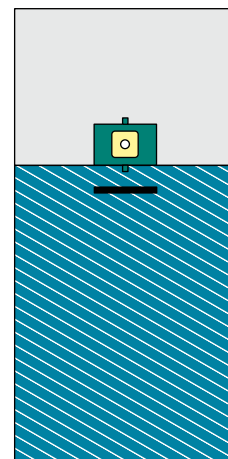

**OPHTHALMIC DRAPE**

**1214**

/24

- 145x295 cm, incise area 10x10 cm, wrapped

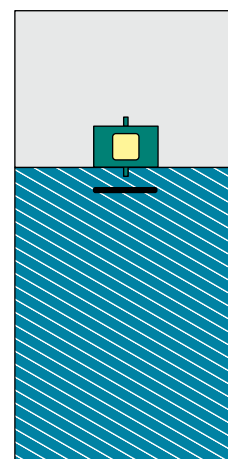

**ADHESIVE APERTURE DRAPE**

**1272**

/32

9572 104x114 cm, incise area 8x19 cm, wrapped

/90

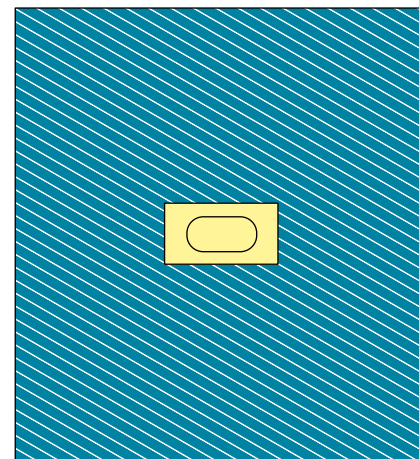

**OPHTHALMIC DRAPE W/ POUCH**

**8005350**

/10

8059 146x160 cm, incise area 12.5x10 cm,  
aperture 6.5x2.5cm, wrapped

/16

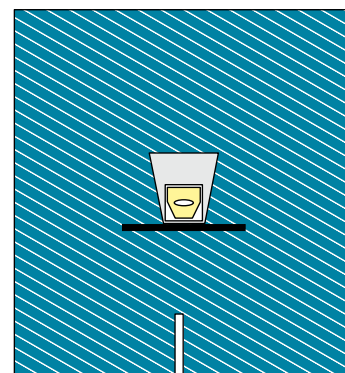

OPHTHALMIC DRAPE W/ POUCHES

8005390

/15

8027 128x146 cm, incise area 12.5x10 cm, aperture 6.5x4 cm, w/wick, wrapped

/42

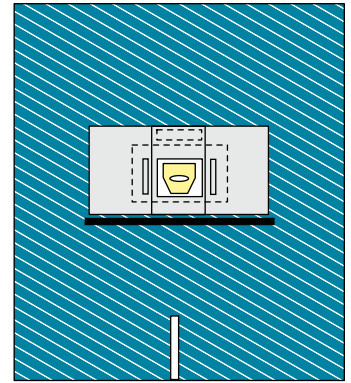

OPHTHALMIC DRAPE W/ POUCHES

8005361

/15

81008026 155x146 cm, incise area 12.5x10 cm, wrapped /42

/42

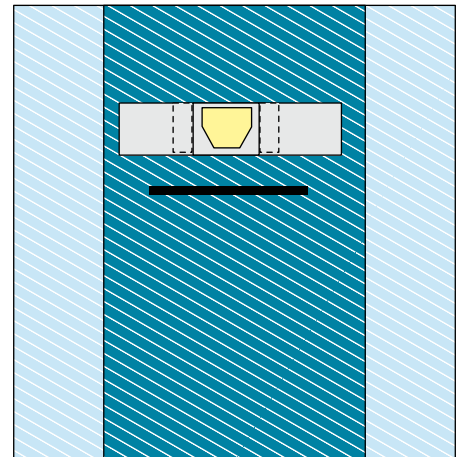

OPHTHALMIC DRAPE W/ POUCH

80051411

/22

80080282 155x146 cm, incise area 8x9.5 cm, wrapped

/52

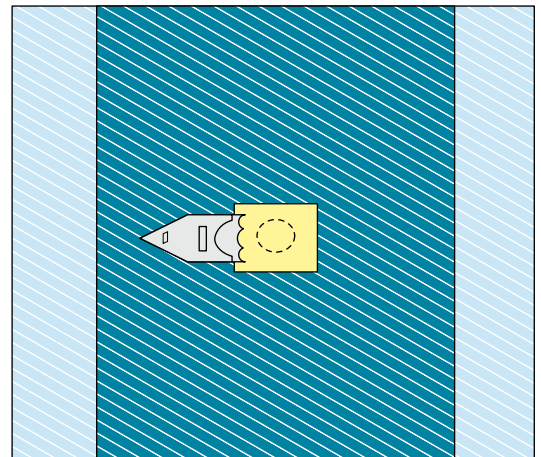

OPHTHALMIC DRAPE

80057565

/35

9922 104x140 cm, incise area 10x8cm, wrapped

/70

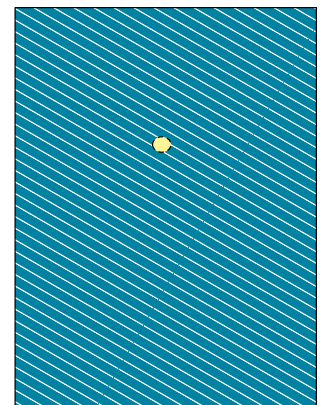





## **ORTHOPAEDIC SETS AND DRAPES**

**HAND/FOOT SET**

**695600**

6/12

- 996109 1 mayo stand cover reinforced 79x145 cm, 65x85 cm absorbent
- 950256 1 hand & foot drape 230x315 cm, aperture 3,5 cm elastic
- 914080 1 table cover 150x190 cm, 75x190 cm absorbent

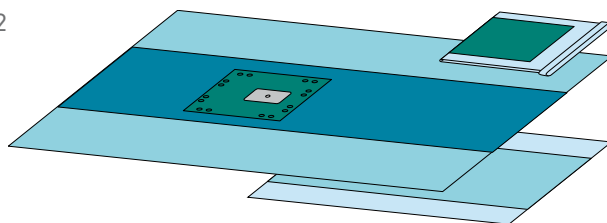

**HAND/FOOT SET**

**695620**

11/22

- 950252 1 hand/foot drape 150x180 cm, aperture 3,5 cm elastic
- 914080 1 table cover 150x190 cm, 75x190 cm absorbent

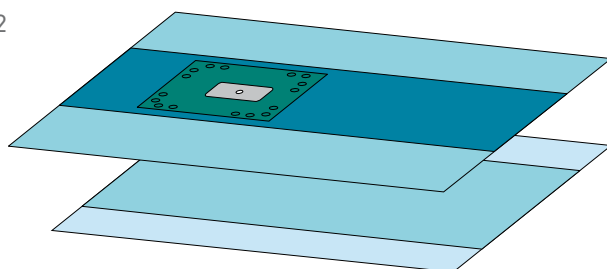

**HAND SET**

**695650**

8/16

- 985650 1 hand drape 150/370x285 cm, aperture 3 cm elastic
- 914080 1 table cover 150x190 cm, 75x190 cm absorbent

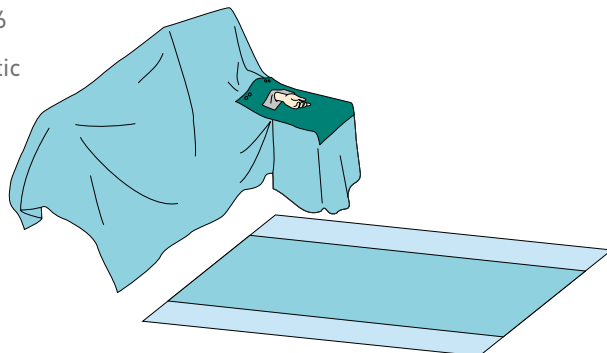

**HAND SET**

**695651**

7/14

- 914079 1 table cover 100x150 cm, 75x150 cm absorbent
- 985650 1 hand drape 150/370x285 cm, aperture 3 cm elastic
- 914080 1 table cover 150x190 cm, 75x190 cm absorbent

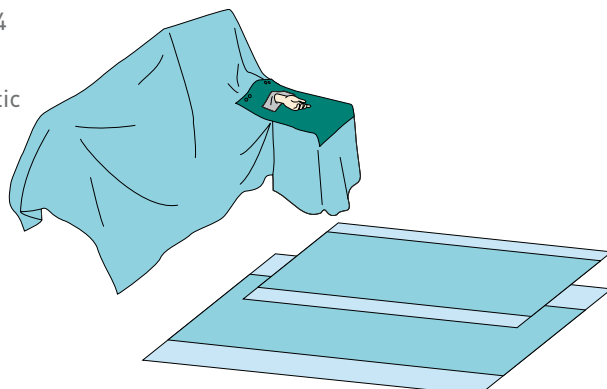

**HAND SET**

**695660**

7/14

- 996106 1 mayo stand cover 79x145 cm, 65x85 cm absorbent
- 985650 1 hand drape 150/370x285 cm, aperture 3 cm elastic
- 914080 1 table cover 150x190 cm, 75x190 cm absorbent

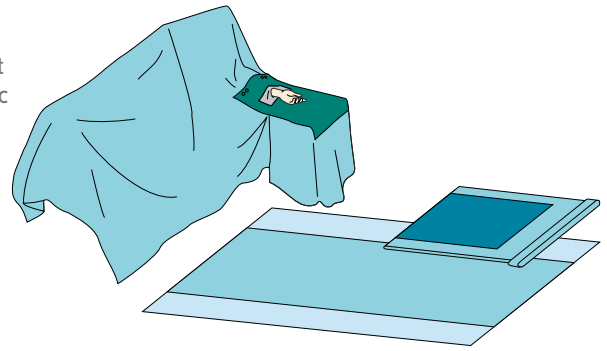

**KNEE ARTHROSCOPY SET**

**695900**

7/14

- 958259 1 knee arthroscopy drape 230x320 cm, aperture 5 cm elastic
- 914080 1 table cover 150x190 cm, 75x190 cm absorbent

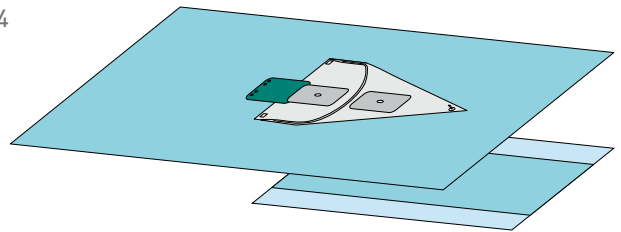

**KNEE ARTHROSCOPY SET**

**695930**

5/10

- 996106 1 mayo stand cover 79x145 cm, 65x85 cm absorbent
- 4 cellulose towel 19x25 cm
- 914080 1 table cover 150x190 cm, 75x190 cm absorbent
- 911510 2 op-tape 9x49 cm
- 946111 1 stockinet small 22x75 cm
- 958259 1 knee arthroscopy drape 230x320 cm, aperture 5 cm elastic
- 914080 1 table cover 150x190 cm, 75x190 cm absorbent

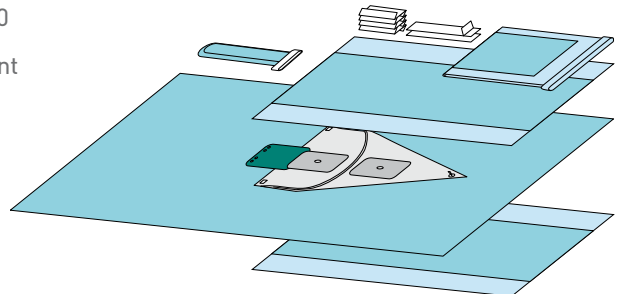

**EXTREMITY SET, BILATERAL KNEE**

**696000**

7/14

- 2 cellulose towel 19x25 cm
- 911510 2 op-tape 9x49 cm
- 950260 1 bilateral knee drape 200/250x320 cm, aperture 5x7 cm elastic
- 948090 1 table cover reinforced 150x190 cm, 65x190 cm absorbent

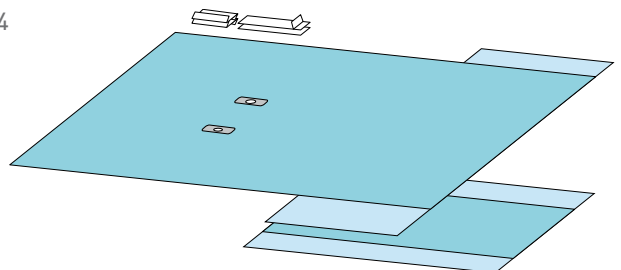

**EXTREMITY SET**

**697320**

7/14

- 911510 1 op-tape 9x49 cm
- 958252 1 extremity drape 230x315 cm, aperture 7 cm elastic
- 914080 1 table cover 150x190 cm, 75x190 cm absorbent

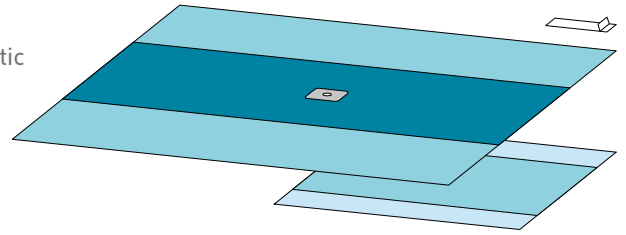

**EXTREMITY SET**

**697400**

5/10

- 996109 1 mayo stand cover reinforced 79x145 cm, 65x85 cm absorbent
- 914080 1 table cover 150x190 cm, 75x190 cm absorbent
- 4 cellulose towel 19x25 cm
- 911510 2 op-tape 9x49 cm
- 910598 1 adhesive towel 75x75 cm
- 950255 1 extremity drape 230x315 cm, aperture 7 cm elastic
- 914080 1 table cover 150x190 cm, 75x190 cm absorbent

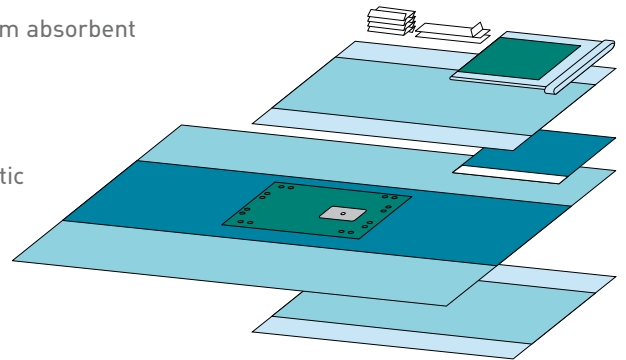

**EXTREMITY SET**

**697800**

5/10

- 996109 1 mayo stand cover reinforced 79x145 cm, 65x85 cm absorbent
- 914080 1 table cover 150x190 cm, 75x190 cm absorbent
- 4 cellulose towel 19x25 cm
- 911510 2 op-tape 9x49 cm
- 946111 1 stockinet small 22x75 cm
- 950255 1 extremity drape 230x315 cm, aperture 7 cm elastic
- 914080 1 table cover 150x190 cm, 75x190 cm absorbent

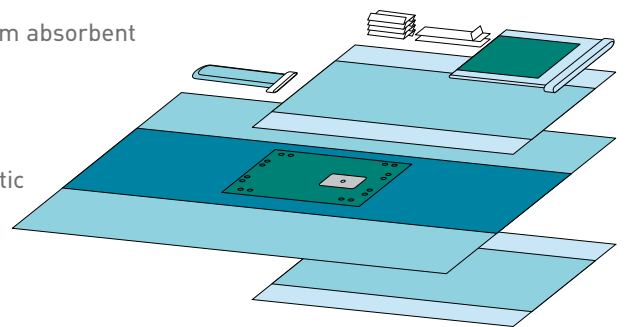

**HIP SET**

**698285**

5/10

- 4 cellulose towel 19x25 cm
- 911510 2 op-tape 9x49 cm
- 4500011 1 adhesive split sheet 150x200 cm plastic, split 20x80 cm
- 988286 1 hip drape 230/300x350 cm, aperture 16x19 cm elastic
- 914080 1 table cover 150x190 cm, 75x190 cm absorbent

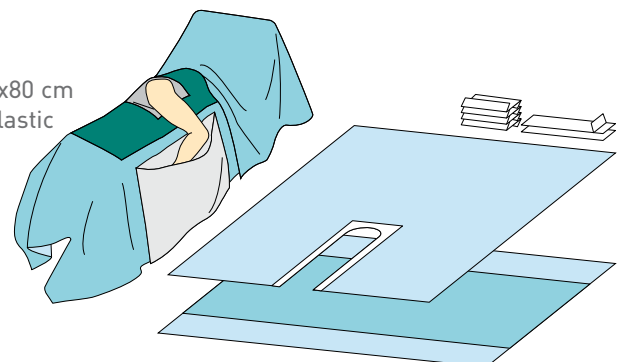

HIP SET

698286

3/6

- 996109 1 mayo stand cover reinforced 79x145 cm, 65x85 cm absorbent
- 4 cellulose towel 19x25 cm
- 911510 2 op-tape 9x49 cm
- 914080 1 table cover 150x190 cm, 75x190 cm absorbent
- 1 suction & diathermy bag 38x33 cm
- 946112 1 stockinet large 32x120 cm
- 910598 2 adhesive towel 75x75 cm
- 988286 1 hip drape 230/300x350 cm, aperture 16x19 cm elastic
- 914080 1 table cover 150x190 cm, 75x190 cm absorbent

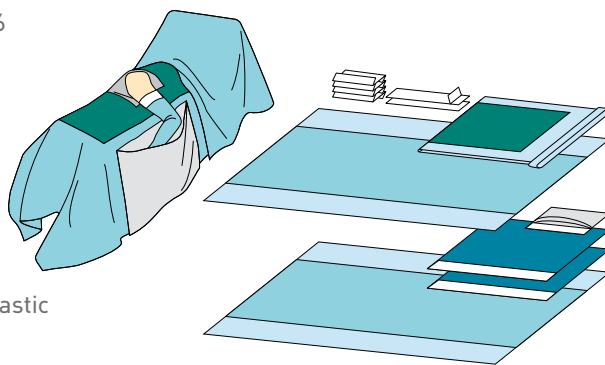

HIP SET

698400

4/8

- 996109 1 mayo stand cover reinforced 79x145 cm, 65x85 cm absorbent
- 4 cellulose towel 19x25 cm
- 968005 1 utility drape 75x90 cm
- 914080 1 table cover 150x190 cm, 75x190 cm absorbent
- 910184 1 op-sheet 90x150 cm
- 911510 3 op-tape 9x49 cm
- 967782 1 adhesive op-sheet 300x175 cm
- 980794 1 adhesive split sheet 200x260 cm, split 7x102 cm
- 914080 1 table cover 150x190 cm, 75x190 cm absorbent

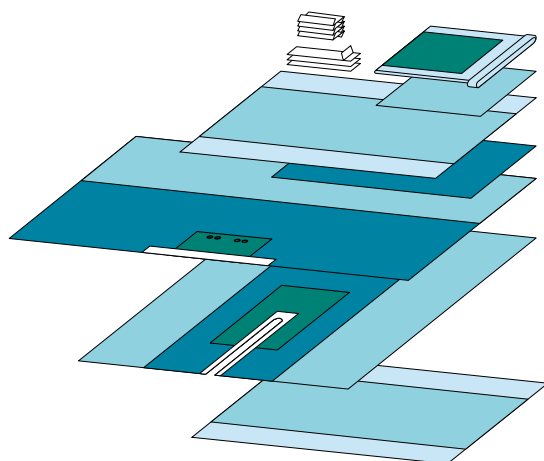

HIP SET

698440

4/8

- 996109 1 mayo stand cover reinforced 79x145 cm, 65x85 cm absorbent
- 4 cellulose towel 19x25 cm
- 968005 1 utility drape 75x90 cm
- 914080 1 table cover 150x190 cm, 75x190 cm absorbent
- 910184 1 op-sheet 90x150 cm
- 911510 3 op-tape 9x49 cm
- 967782 1 adhesive op-sheet 300x175 cm
- 950798 1 adhesive split sheet 200x260 cm, split 20x102 cm
- 914080 1 table cover 150x190 cm, 75x190 cm absorbent

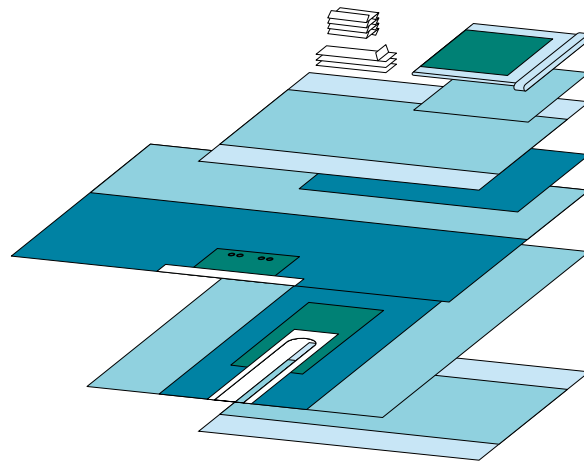

HIP SET

698500

4/8

- 996109 1 mayo stand cover reinforced 79x145 cm, 65x85 cm absorbent
- 4 cellulose towel 19x25 cm
- 968005 1 utility drape 75x90 cm
- 914080 1 table cover 150x190 cm, 75x190 cm absorbent
- 946112 1 stockinet large 32x120 cm
- 911510 2 op-tape 9x49 cm
- 980794 1 adhesive split sheet 200x260 cm, split 7x102 cm
- 967782 1 adhesive op-sheet 300x175 cm
- 914080 1 table cover 150x190 cm, 75x190 cm absorbent

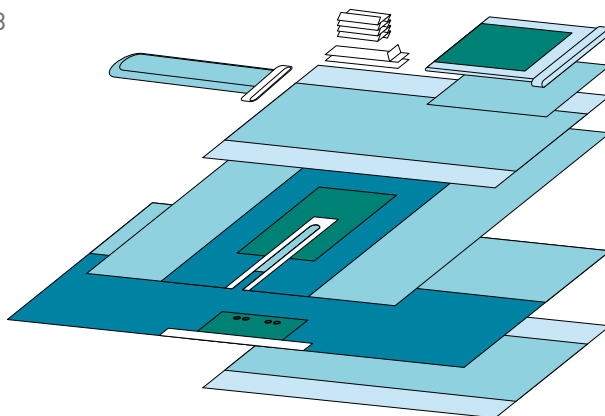

HIP SET

698540

4/8

- 996109 1 mayo stand cover reinforced 79x145 cm, 65x85 cm absorbent
- 4 cellulose towel 19x25 cm
- 968005 1 utility drape 75x90 cm
- 914080 1 table cover 150x190 cm, 75x190 cm absorbent
- 946112 1 stockinet large 32x120 cm
- 911510 2 op-tape 9x49 cm
- 950798 1 adhesive split sheet 200x260 cm, split 20x102 cm
- 967782 1 adhesive op-sheet 300x175 cm
- 914080 1 table cover 150x190 cm, 75x190 cm absorbent

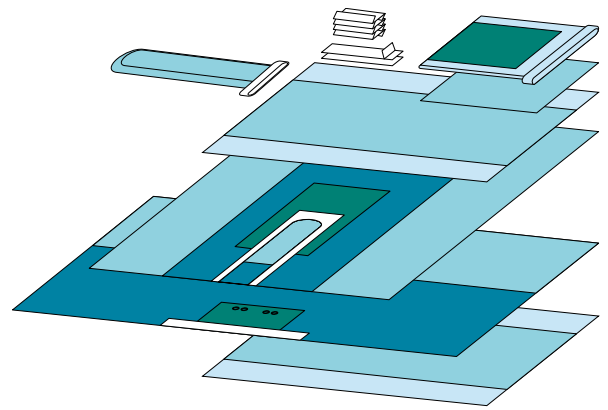

HIP SET

698550

4/8

- 996109 1 mayo stand cover reinforced 79x145 cm, 65x85 cm absorbent
- 4 cellulose towel 19x25 cm
- 968005 1 utility drape 75x90 cm
- 914080 1 table cover 150x190 cm, 75x190 cm absorbent
- 946112 1 stockinet large 32x120 cm
- 911510 2 op-tape 9x49 cm
- 950797 1 adhesive split sheet 230x330 cm, split 20x102 cm
- 967782 1 adhesive op-sheet 300x175 cm
- 914080 1 table cover 150x190 cm, 75x190 cm absorbent

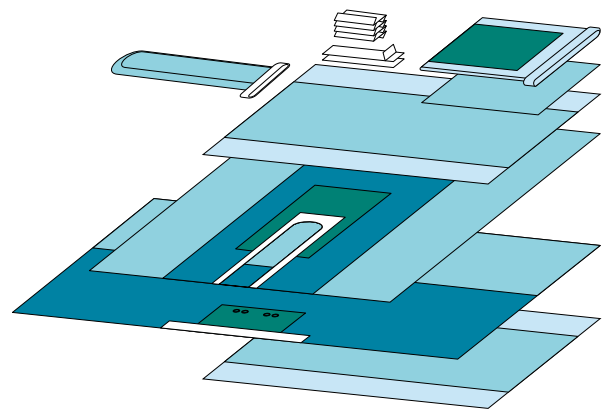

HIP SET

698670

3/6

- 996109 1 mayo stand cover reinforced 79x145 cm, 65x85 cm absorbent
- 910519 1 op-towel 75x90 cm
- 4 cellulose towel 19x25 cm
- 946112 1 stockinet large 32x120 cm
- 950798 1 adhesive split sheet 200x260 cm, split 20x102 cm
- 914080 1 table cover 150x190 cm, 75x190 cm absorbent
- 910598 2 adhesive towel 75x75 cm
- 967775 1 adhesive op-sheet 175x175 cm
- 911510 3 op-tape 9x49 cm
- 977035 1 suction and diathermy bag 40x35 cm
- 967782 1 adhesive op-sheet 300x175 cm
- 914080 1 table cover 150x190 cm, 75x190 cm absorbent

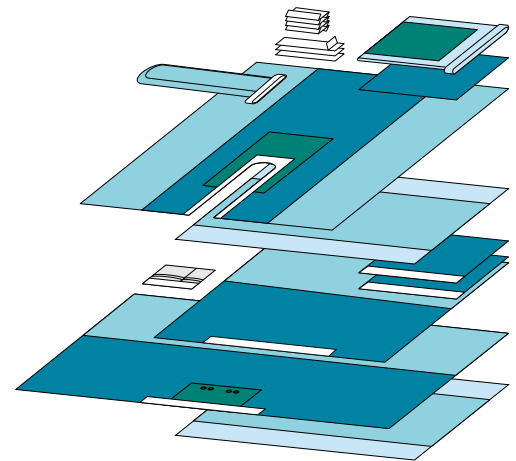

HIP SET

698840

4/8

- 4 cellulose towel 19x25 cm
- 967772 1 adhesive op-sheet 175x175 cm
- 911510 1 op-tape 9x49 cm
- 950798 1 adhesive split sheet 200x260 cm, split 20x102 cm
- 967782 1 adhesive op-sheet 300x175 cm
- 914080 1 table cover 150x190 cm, 75x190 cm absorbent

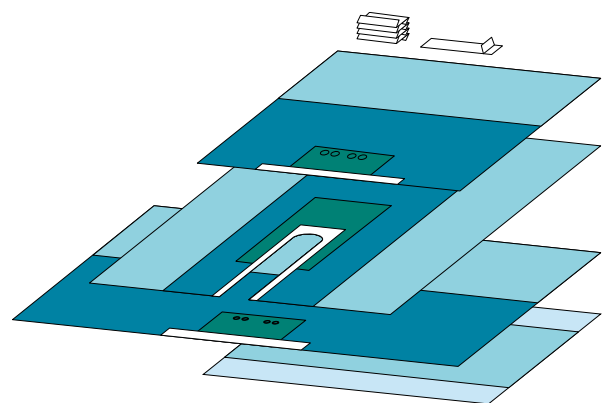

**VERTICAL ISOLATION SET**

**903014**

8/16

- 4 cellulose towel 30x24 cm
- 815301 1 vertical isolation drape 330x240 cm, incise area 30x40 cm
- 914080 1 table cover 150x190 cm, 75x190 cm absorbent

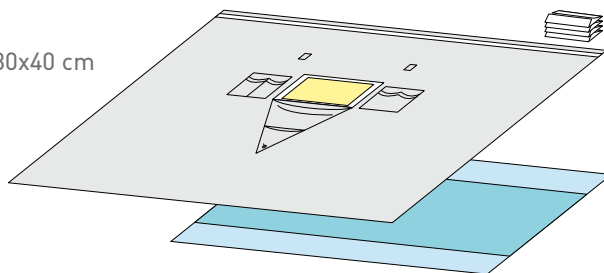

**VERTICAL ISOLATION SET**

**903016**

7/14

- 996109 1 mayo stand cover reinforced 79x145 cm, 65x85 cm absorbent
- 4 cellulose towel 30x24 cm
- 815301 1 vertical isolation drape 330x240 cm, incise area 30x40 cm
- 914080 1 table cover 150x190 cm, 75x190 cm absorbent

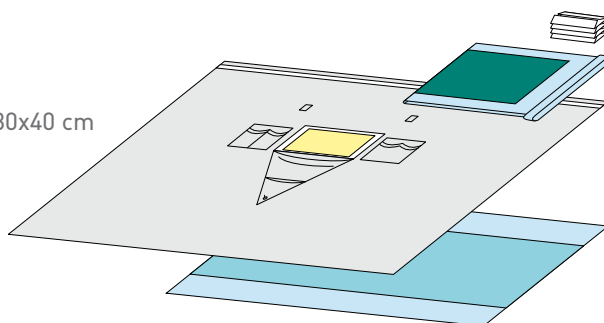

**VERTICAL ISOLATION SET**

**903026**

6/12

- 996109 1 mayo stand cover reinforced 79x145 cm, 65x85 cm absorbent
- 4 cellulose towel 30x24 cm
- 815300 1 vertical isolation drape 330x240 cm, incise area 25x86 cm
- 914080 1 table cover 150x190 cm, 75x190 cm absorbent

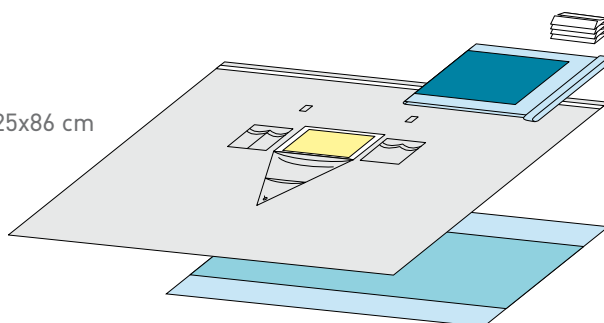

**HIP SET**

**904235**

4/8

- 4 cellulose towel 19x25 cm
- 911510 2 op-tape 9x49 cm
- 910185 1 op-sheet 150x175 cm
- 967782 1 adhesive op-sheet 300x175 cm
- 4500011 1 adhesive split sheet 150x200 cm plastic, split 20x80 cm
- 950798 1 adhesive split sheet 200x260 cm, split 20x102 cm
- 914080 1 table cover 150 x 190 cm, 75x190 cm absorbent

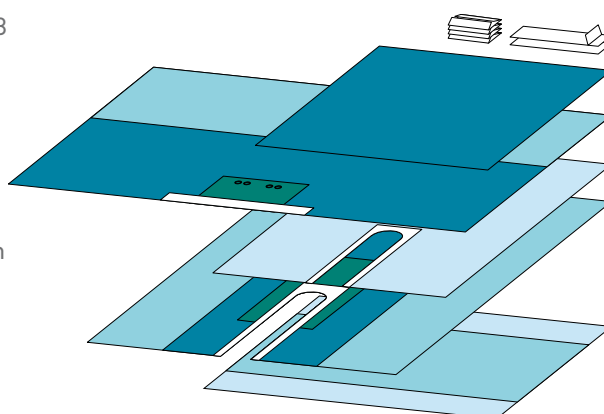

UPPER EXTREMITY SET

904280

5/10

- 911510 1 op-tape 9x49 cm
- 910185 1 op-sheet 150x175 cm
- 967775 1 adhesive op-sheet 175x175 cm
- 950256 1 hand & foot drape 230x315 cm, aperture 3,5 cm elastic, patch 70x70 cm
- 914080 1 table cover 150x190 cm, 75x190 cm absorbent

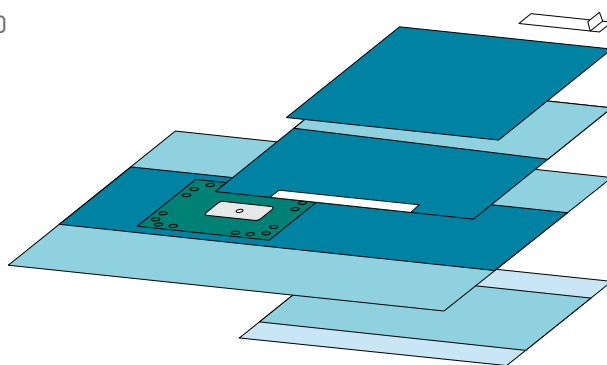

UPPER EXTREMITY SET

904282

4/8

- 996106 1 mayo stand cover 79x145 cm, 65x85 cm absorbent
- 4 cellulose towel 19x25 cm
- 911510 2 op-tape 9x49 cm
- 815332 1 tube/camera cover perforated tip 12x240 cm
- 930200 1 adhesive towel 90x75 cm
- 904753 1 shoulder drape 200x280 cm, split 25x25 cm + 35 cm
- 815312 1 fluid collection pouch 76x100 cm
- 904754 1 adhesive split sheet 250x200cm, split 20x60 cm
- 914080 1 table cover 150x190 cm, 75x190 cm absorbent

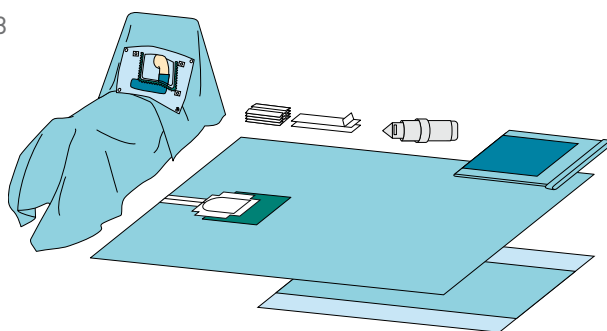

HIP SET

904739

3/6

- 996109 2 mayo stand cover reinforced 79x145 cm, 65x85 cm absorbent
- 4 cellulose towel 19x25 cm
- 911510 3 op-tape 9x49 cm
- 1 elastic bandage 12 cm x 6 m
- 977035 1 fluid collection bag 40x35 cm
- 914079 1 table cover 100x150 cm, 75x150 cm absorbent
- 946112 1 stockinet large 32x120 cm
- 910519 2 op-towel 75x90 cm
- 930200 3 adhesive towel 90x75 cm
- 967775 1 adhesive op-sheet 175x175 cm
- 967782 1 adhesive op-sheet 300x175 cm
- 950798 1 adhesive split sheet 200x260 cm, split 20x102 cm
- 948090 1 table cover reinforced 150x190 cm, 65x190 cm absorbent

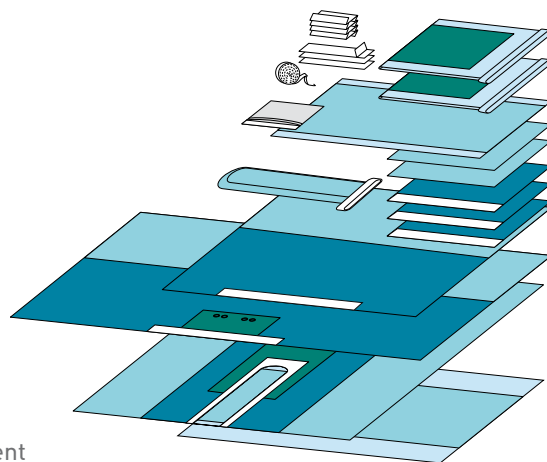

HIP SET

920256

3/6

- 996109 1 mayo stand cover reinforced 79x145 cm, 65x85 cm absorbent
- 4 cellulose towel 19x25 cm
- 911510 3 op-tape 9x49 cm
- 1 elastic bandage 12 cmx6 m
- 946112 1 stockinet large 32x120 cm
- 930200 2 adhesive towel 90x75 cm
- 967775 1 adhesive op-sheet 175x175 cm
- 967773 1 adhesive op-sheet 240x150 cm
- 950798 1 adhesive split sheet 200x260 cm, split 20x102 cm
- 948090 1 table cover reinforced 150x190 cm, 65x190 cm absorbent

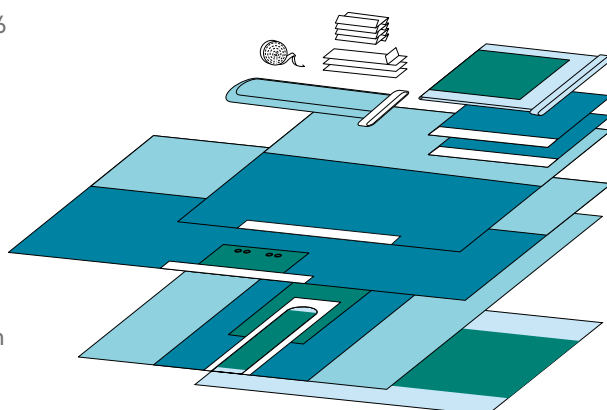



**ORTHOPAEDIC SET**

**969074**

3/6

- 2 cellulose towel 19x25 cm
- 948090 1 table cover 150x190 cm,  
75x190 cm absorbent reinforced
- 967774 1 adhesive op-sheet 175x150 cm
- 911510 3 op-tape 9x49 cm
- 980794 2 split sheet 200x260 cm, split 7x102 cm
- 967782 1 adhesive op-sheet 300x175 cm
- 948090 1 table cover reinforced 150x190 cm,  
75x190 cm absorbent
- 1 wrap 100x140 cm

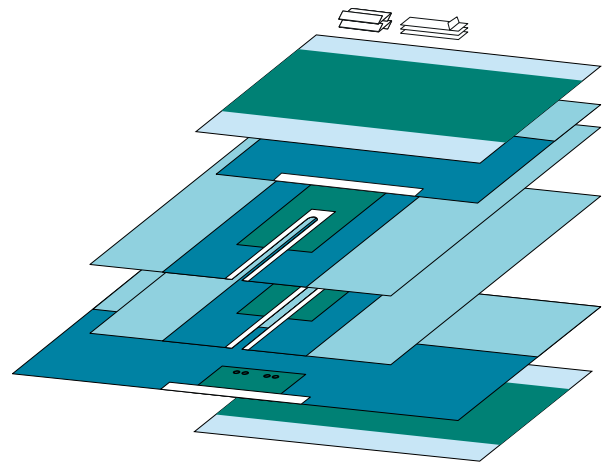

**EXTREMITY SET**

**969075**

6/12

- 2 cellulose towel 19x25 cm
- 914079 1 table cover 100x150 cm, 75x150 cm absorbent
- 911510 2 op-tape 9x49 cm
- 950255 1 extremity drape 230x315 cm,  
aperture 7 cm elastic
- 948090 1 table cover reinforced 150x190 cm,  
65x190 cm absorbent
- 1 wrap 100x100 cm

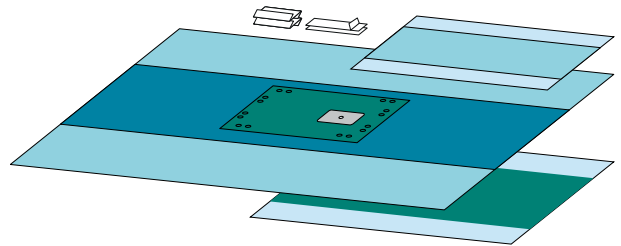

**HAND/FOOT SET**

**969076**

7/14

- 950256 1 hand & foot drape 230x315 cm,  
aperture 3,5 cm elastic, patch 70x70 cm
- 948090 1 table cover reinforced 150x190 cm,  
65x190 cm absorbent
- 1 wrap 100x100 cm

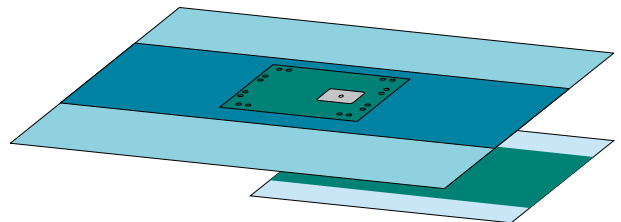

**EXTREMITY SET**

**969078**

6/12

- 911510 1 op-tape 9x49 cm
- 950255 1 extremity drape 230x315 cm, aperture 7 cm elastic
- 914080 1 table cover 150x190 cm, 75x190 cm absorbent

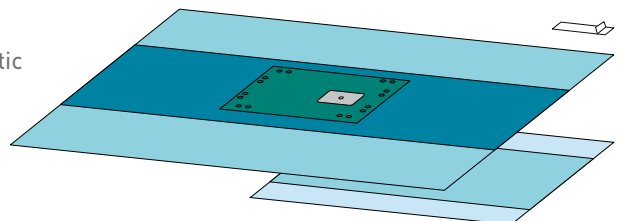

**EXTREMITY SET, BILATERAL FOOT**

**969079**

7/14

- 2 cellulose towel 19x25 cm
- 911510 2 op-tape 9x49 cm
- 950259 1 bilateral foot drape 200/250x320 cm,  
apertures 4 cm elastic
- 948090 1 table cover reinforced 150x190 cm,  
65x190 cm absorbent

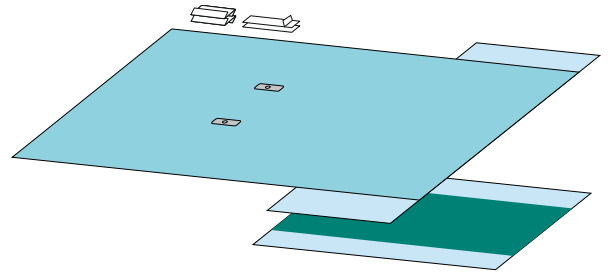

**KNEE ARTHROSCOPY SETO**

171

/7

- 1 suture bag 16.5x28.5 cm
- 9521 3 op-tape 10x60 cm
- 9544 1 mayo stand cover 58x137 cm, 45x56 cm absorbent
- 9214 1 prep pad 61x112 cm, split 10x36 cm
- 9057 1 stockinet 31x122 cm
- 9475 1 adhesive split sheet 152x193 cm plastic, split 15x61 cm
- 9568 1 knee arthroscopy drape w/pouch 257x305 cm, aperture 6 cm, elastic
- 93032 1 table cover reinforced 140x215 cm, 61x152 cm absorbent

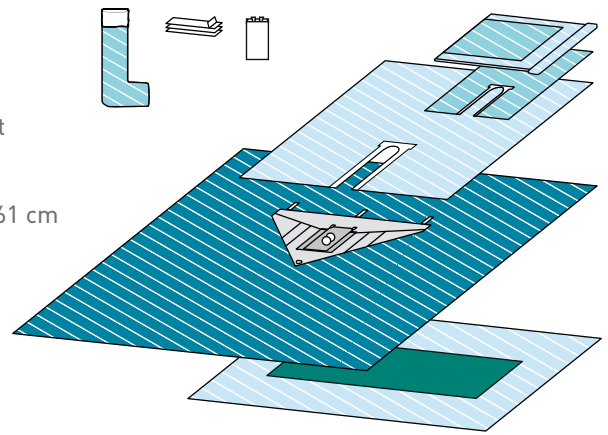

**ARTHROSCOPY SET IV**

174

/7

- 9214 1 prep pad 61x112 cm, split 10x36 cm
- 9544 1 mayo stand cover 58x137 cm, 45x56 cm absorbent
- 9057 1 stockinet 31x122 cm
- 1 suture bag 16.5x28.5 cm
- 9475 1 adhesive split sheet 152x193 cm plastic, split 15x61 cm
- 9521 3 op-tape 10x60 cm
- 9270 1 extremity drape 257x320 cm, reinforcement 91x122 cm, aperture 6 cm elastic
- 930324 1 table cover reinforced 140x215 cm, 61x152 cm absorbent

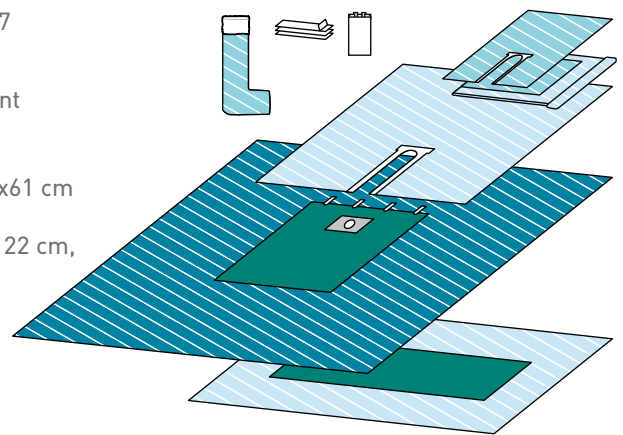

**HIP SET IV**

176

/6

- 9544 1 mayo stand cover 58x137 cm, 45x56 cm absorbent
- 9057 1 stockinet 31x122 cm
- 9527 1 patient drape 104x178 cm
- 9475 1 adhesive split sheet 152x193 cm plastic, split 15x61 cm
- 1 suture bag 16.5x28.5 cm
- 9692 1 hip split sheet 208x295 cm, reinforcement 91x173 cm, split 105 cm, aperture 20x37 cm
- 930324 1 table cover reinforced 140x215 cm, 61x152 cm absorbent

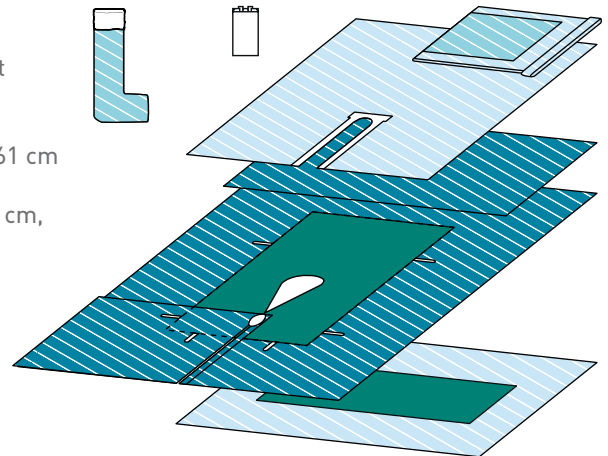

**SHOULDER SET III**

177

/7

- 9544 1 mayo stand cover 58x137 cm, 45x56 cm absorbent
- 9521 3 op-tape 10x60 cm
- 1 suture bag 16.5x28.5 cm
- 9475 1 adhesive split sheet 152x193 cm plastic, split 15x61 cm
- 9816 1 body split sheet 206x295 cm, reinforcement 61x91cm, split 10x69 cm
- 9716 1 shoulder split sheet 254x168 cm, split 15x20 cm
- 930324 1 table cover reinforced 140x215 cm, 61x152 cm absorbent

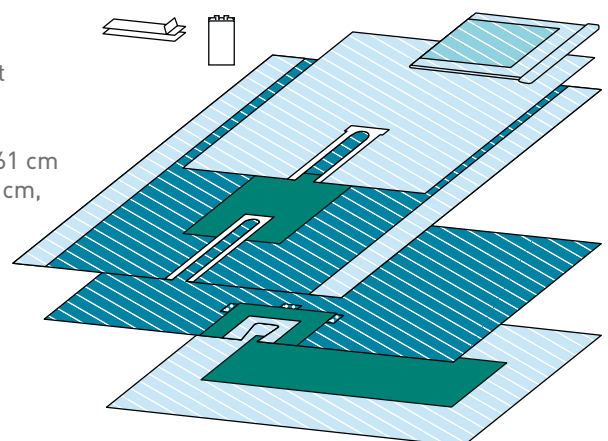

**LOWER EXTREMITY SET II**

179

/5

- 9544 1 mayo stand cover 58x137 cm, 45x56 cm absorbent
- 9475 1 adhesive split sheet 152x193 cm plastic, split 15x61 cm
- 9057 1 stockinet 31x122 cm
- 1 suture bag 16.5x28.5 cm
- 9207 1 adhesive Hinged split sheet 208x254 cm, reinforcement 91x173 cm, split 11x103 cm
- 9561 1 adhesive patient drape 254x183 cm, reinforcement 46x91 cm
- 930324 1 table cover reinforced 140x215 cm, 61x152 cm absorbent

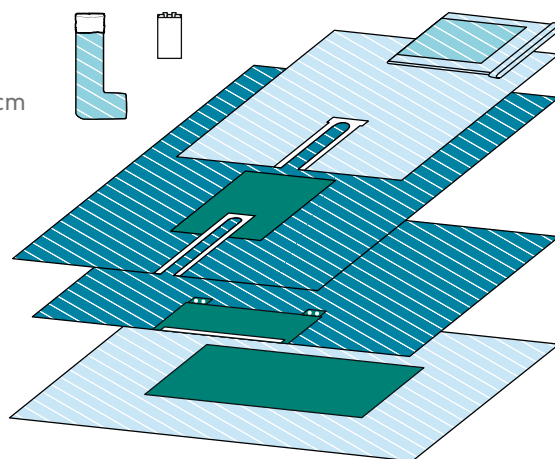

**SHOULDER SET W/ ATTACHED POUCH**

295

/10

- 9724 1 shoulder split sheet w/pouch 254x168 cm, split 15x46 cm
- 9824 1 body split sheet 206x295 cm, split 10x69 cm
- 1 wrap 86x86 cm

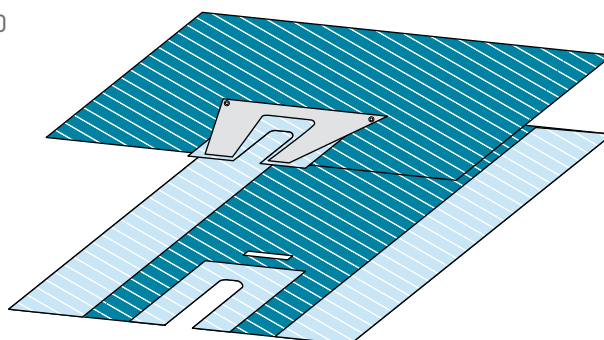

**ORTHOPAEDIC SET**

1264

/7

- 9544 1 mayo stand cover 58x137 cm, 45x56 cm absorbent
- 1 suture bag 16.5x28.5 cm
- 9475 1 adhesive split sheet 152x193 cm plastic, split 15x61 cm
- 9528 1 patient drape 145x196 cm
- 9598 1 adhesive split sheet 208x295 cm, reinforcement 46x122 cm, split 10x119 cm
- 9660 1 table cover 140x215 cm, 66x215 cm absorbent

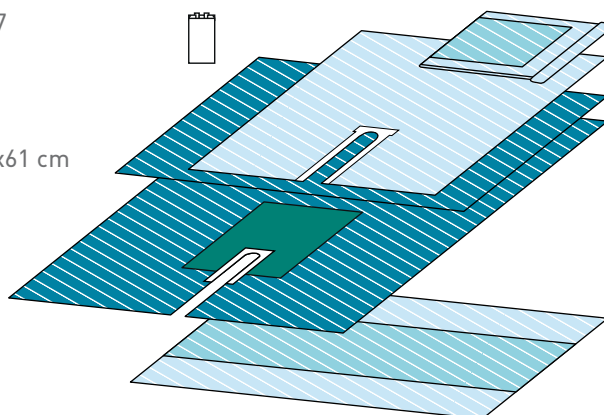

**HIP SET**

70057470

/3

- 80057485 1 utility drape 104x114 cm
- 9057 1 stockinet 31x122 cm
- 8008049 1 adhesive patient drape 183x155 cm
- 80008020 1 adhesive split sheet 208x254 cm, reinforcement 91.5x90 cm, split 10x37 + 53 cm
- 930324 1 table cover reinforced 140x215 cm, 61x152 cm absorbent

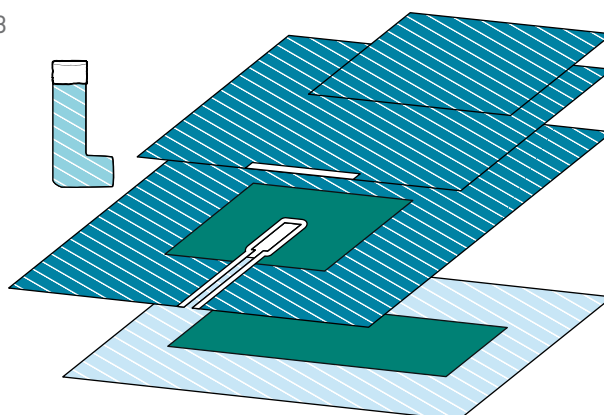

**HIP SET II**

**70057499**

/5

- 1 cellulose towel 50x50 cm
- 80057485 1 utility drape 104x114 cm
- 8008049 1 adhesive patient drape 183x155 cm
- 80008020 1 adhesive split sheet 208x254 cm, reinforcement 91.5x90 cm, split 10x37 + 53 cm
- 930324 1 table cover reinforced 140x215 cm, 61x152 cm absorbent

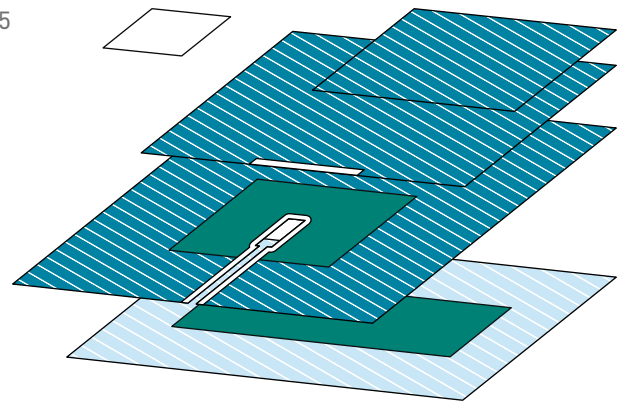

**BEACH CHAIR SHOULDER SET**

**80005163**

/6

- 8046 1 mayo stand cover reinforced 79x145 cm, Pad 61x85 cm
- 1 stockinet 18x86 cm
- 8081 2 op-tape 9x50 cm
- 8014 1 adhesive utility drape 90x75 cm
- 1 cellulose towel 50x50 cm
- 9294 1 beach chair shoulder drape 257x406 cm, aperture 15x15 cm, elastic
- 9370 1 table cover reinforced 127x229 cm, Pad 61x152 cm

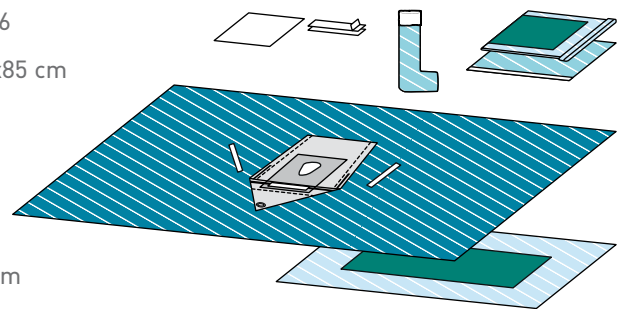

**SPINAL SET**

**80005471**

/6

- 8008049 1 adhesive patient drape 183x155 cm
- 80008030 1 spinal drape 240x320 cm, incise area 30x60 cm
- 930324 1 table cover reinforced 140x215 cm, 61x152 cm absorbent

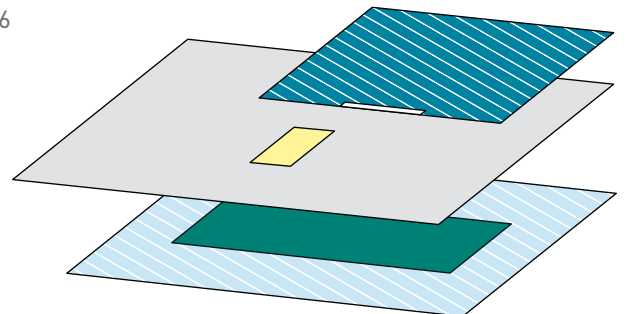

**HIP SET**

**80005501**

/5

- 750114 1 surgical gown XXLL + 2 hand towels 50x50 cm, wrapped
- 750114 1 surgical gown XXLL + 2 hand towels 50x50 cm, wrapped
- 1 cellulose towel 50x50 cm
- 8046 1 mayo stand cover reinforced 79x145 cm, Pad 61x85 cm
- 922803 1 adhesive utility drape 90x79 cm
- 8081 1 op-tape 9x50 cm
- 80008041 1 diathermy pouch 30x40 cm
- 8079 1 adhesive split sheet 183x290 cm, reinforcement 61x180 cm, split 10x92 cm
- 1 adhesive patient drape 240x183 cm. reinforcement 30x80 cm
- 9660 1 table cover 140x215 cm, 66x215 cm absorbent

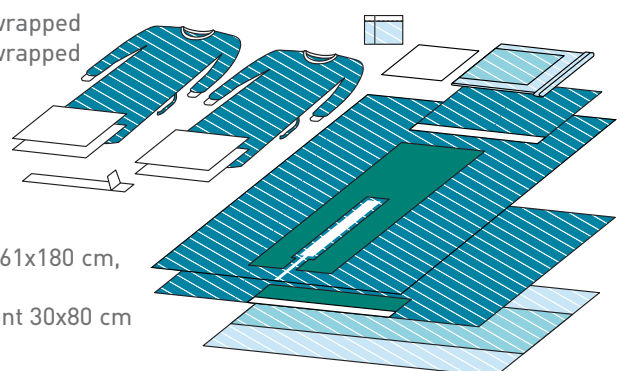

**HIP SET**

**80011671**

/4

- 80057485 1 utility drape 104x114 cm
- 8008049 1 adhesive patient drape 183x155 cm
- 9057 1 stockinet 31x122 cm
- 80008020 1 adhesive split sheet 208x254 cm, reinforcement 91.5x90 cm, split 10x37 + 53 cm
- 1 wrap 86x86 cm

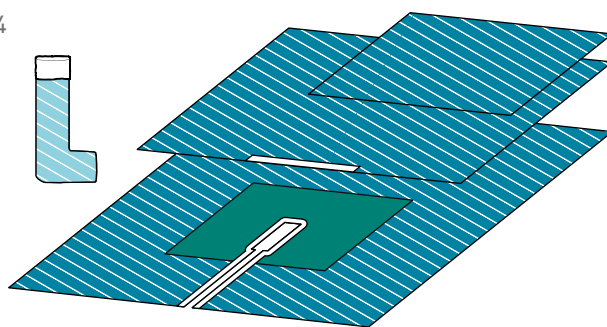

**ORTHOPAEDIC SET**

**80575081**

/3

- 8046 1 mayo stand cover reinforced 79x145 cm, Pad 61x85 cm
- 9057 1 stockinet 31x122 cm
- 80057485 1 utility drape 104x114 cm
- 8081 1 op-tape 9x50 cm
- 80008020 1 adhesive split sheet 208x254 cm, reinforcement 91.5x90 cm, split 10x37 + 53 cm
- 8008051 1 adhesive patient drape 254x183 cm
- 930324 1 table cover reinforced 140x215 cm, 61x152 cm absorbent

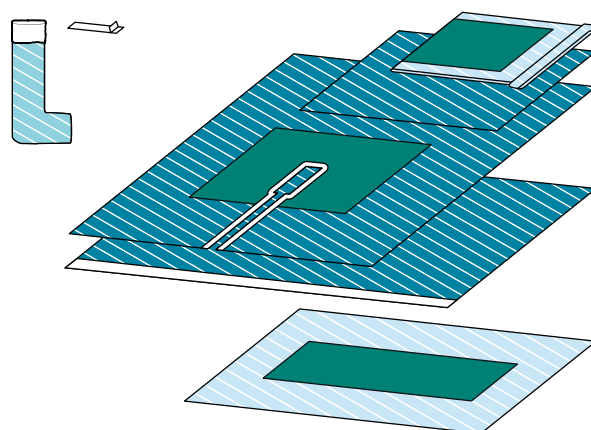

**EXTREMITY SET**

**80575171**

/4

- 8046 1 mayo stand cover reinforced 79x145 cm, Pad 61x85 cm
- 8081 1 op-tape 9x50 cm
- 8008060 1 stockinet 23x71 cm
- 80057485 1 utility drape 104x114 cm
- 926705 1 extremity drape 257x320 cm, reinforcement 91.5x120 cm, aperture 6.5 cm, elastic
- 9660 1 table cover 140x215 cm, 66x215 cm absorbent

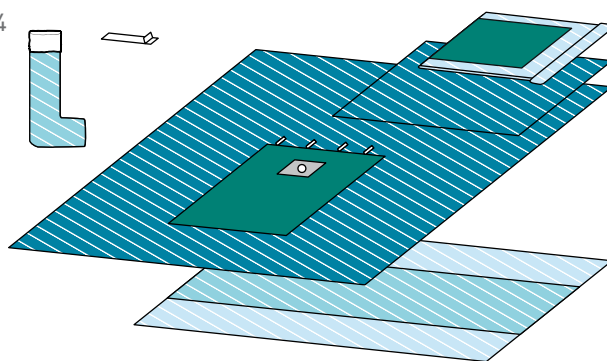

**EXTREMITY SET**

**80575181**

/4

- 8046 1 mayo stand cover reinforced 79x145 cm, Pad 61x85 cm
- 8014 1 adhesive utility drape 90x75 cm
- 8081 1 op-tape 9x50 cm
- 922001 1 patient drape 100x150 cm
- 9671 1 extremity drape 206/256x320 cm, reinforcement 61x122cm, aperture 6 cm, elastic
- 9660 1 table cover 140x215 cm, Pad 66x215 cm

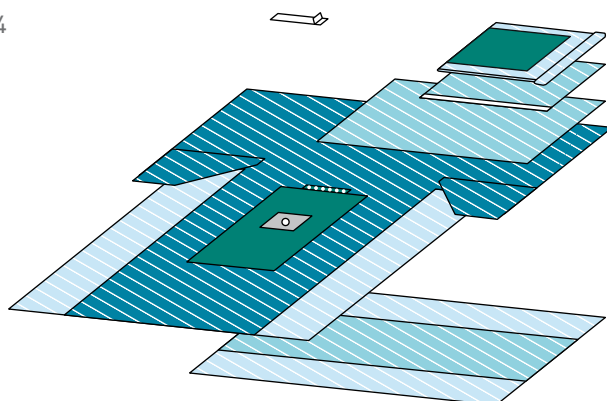

**EXTREMITY SET**

**84511040** /10

- 924105 1 extremity drape 208x300 cm, reinforcement 61x120 cm, aperture 6.5 cm, elastic
- 80008022 1 table cover 140x180 cm, 66x180 cm absorbent

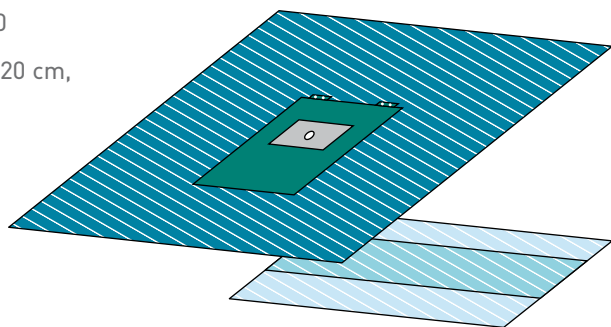

**LOWER EXTREMITY SET**

**84511141** /8

- 922001 1 patient drape 100x150 cm
- 920413 1 adhesive split sheet w/Hinge 183x208 cm, split 10x51 cm
- 921926 1 adhesive patient drape 254x183 cm, reinforcement 30x80 cm
- 80008022 1 table cover 140x180 cm, 66x180 cm absorbent

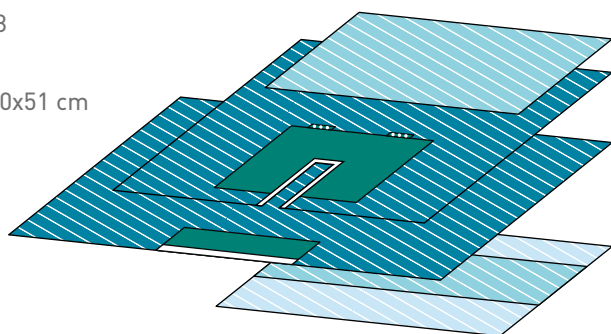

**HIP SET**

**84511221** /7

- 2 op-tape 8x45 cm
- 922001 1 patient drape 100x150 cm
- 920417 1 plastic split sheet 152x200 cm, split 15x60 cm
- 80008020 1 adhesive split sheet 208x254 cm, reinforcement 91.5x90 cm, split 10x37 + 53 cm
- 1 adhesive patient drape 254x183 cm, reinforcement 30x80 cm
- 930324 1 table cover reinforced 140x215 cm, 61x152 cm absorbent

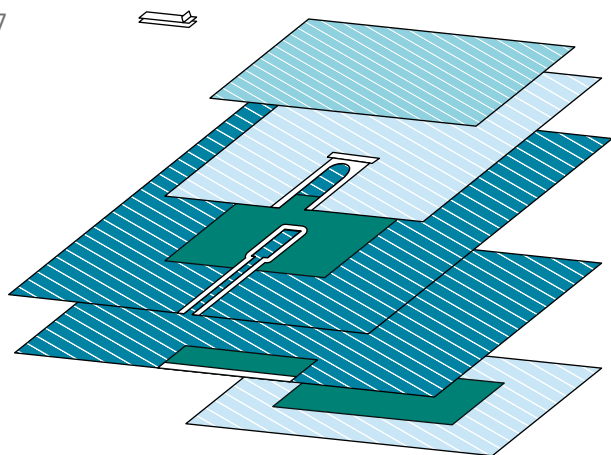

**EXTREMITY SET**

**84511231** /15

- 2 op-tape 8x45 cm
- 1 impermeable extremity drape 220x300 cm, reinforcement 91.5x90 cm, aperture 6.5 cm, elastic
- 80008022 1 table cover 140x180 cm, 66x180 cm absorbent

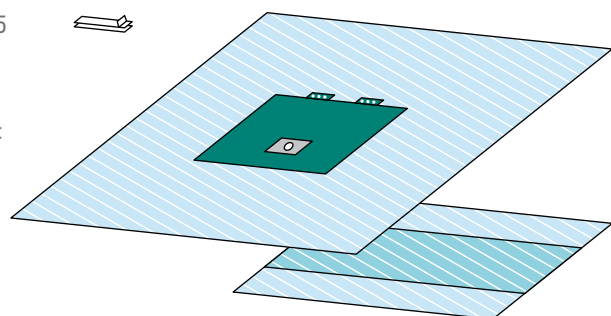

**HAND SET**

84511241

/8

- 924126 1 hand extremity drape 146/380x296 cm, reinforcement 45x125 cm, aperture 2.5 cm, elastic
- 922001 1 patient drape 100x150 cm
- 1 table cover 140x160 cm, 66x160 cm absorbent

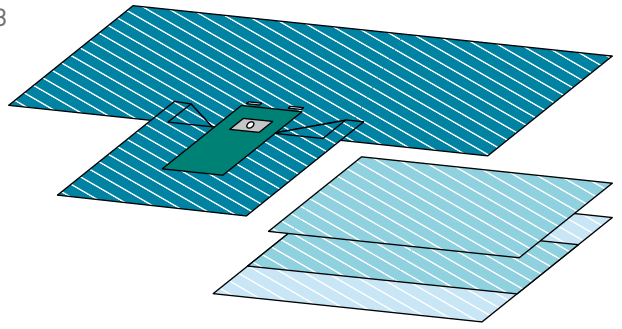

**EXTREMITY SET**

84511301

/10

- 922001 1 patient drape 100x150 cm
- 924105 1 extremity drape 208x300 cm, reinforcement 61x120 cm, aperture 6.5 cm, elastic
- 80008022 1 table cover 140x180 cm, 66x180 cm absorbent

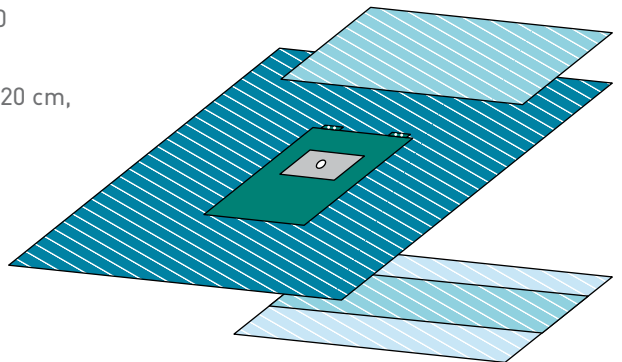

**ARTHROSCOPY SET**

84511351

/6

- 9568 1 knee arthroscopy drape w/pouch 257x305 cm, aperture 6 cm, elastic
- 80008022 1 table cover 140x180 cm, 66x180 cm absorbent

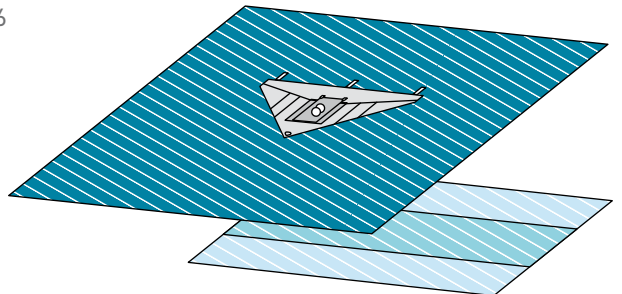

**VERTICAL ISOLATION SET**

84511491

/12

- 2 cellulose towel 50x50 cm
- 80008032 1 Vertical Isolation drape 240x320 cm, Inside area 30x61 cm
- 930324 1 table cover reinforced 140x215 cm, 61x152 cm absorbent

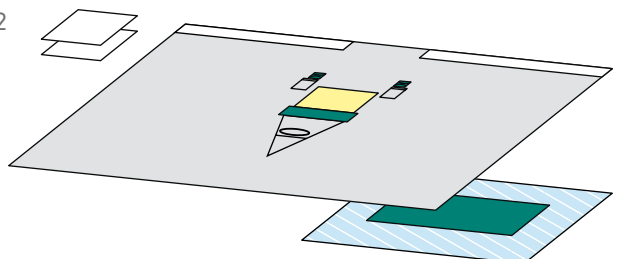



**HIP SET**

**84511511**

/6 

- 2 op-tape 8x45 cm
- 922001 1 patient drape 100x150 cm
- 920305 1 impermeable drape sheet 160x200 cm
- 920417 1 plastic split sheet 152x200 cm, split 15x60 cm
- 920406 1 adhesive split sheet 270x300 cm, reinforcement 91.5x145 cm, split 10x37 cm + 53cm
- 1 adhesive patient drape 254x183 cm, reinforcement 30x80 cm
- 930324 1 table cover reinforced 140x215 cm, 61x152 cm absorbent

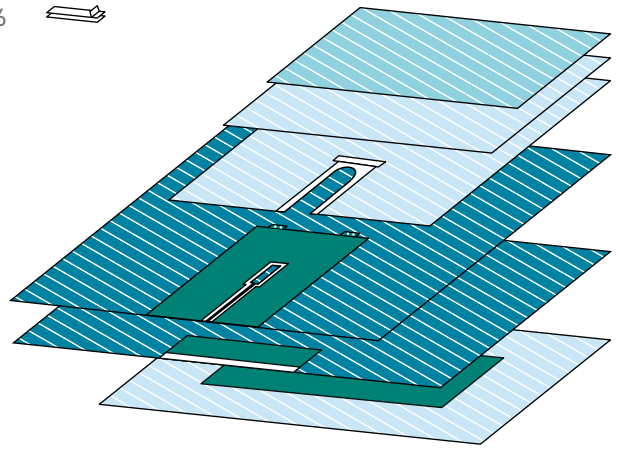

**KNEE SET**

**84511551**

/10 

- 922001 1 patient drape 100x150 cm
- 2 op-tape 8x45 cm
- 926705 1 extremity drape 257x320 cm, reinforcement 91.5x120 cm, aperture 6.5 cm, elastic
- 80008022 1 table cover 140x180 cm, 66x180 cm absorbent

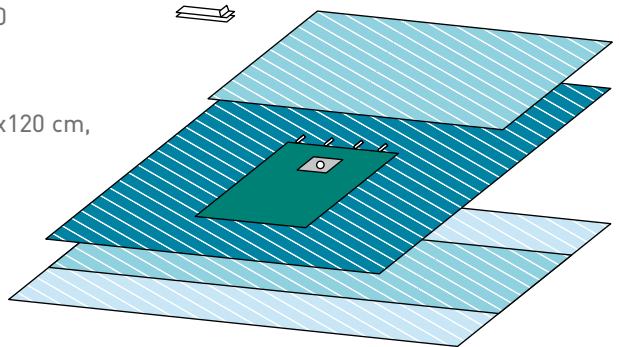

**HAND SET**

**84511561**

/20 

- 9919 1 hand extremity drape 146/280x262 cm, reinforcement 50x110 cm, aperture 2.5 cm, elastic
- 1 table cover 140x180 cm, 66x180 cm absorbent

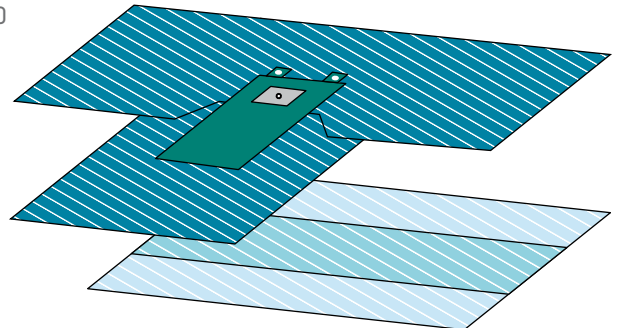

**HIP SET**

**84512222**

/6 

- 2 op-tape 8x45 cm
- 922001 1 patient drape 100x150 cm
- 920417 1 plastic split sheet 152x200 cm, split 15x60 cm
- 920420 1 adhesive split sheet 254x257 cm, reinforcement 91.5x90 cm split 10x37 cm + 53 cm
- 1 adhesive patient drape 254x183 cm, reinforcement 30x80 cm
- 930324 1 table cover reinforced 140x215 cm, 61x152 cm absorbent

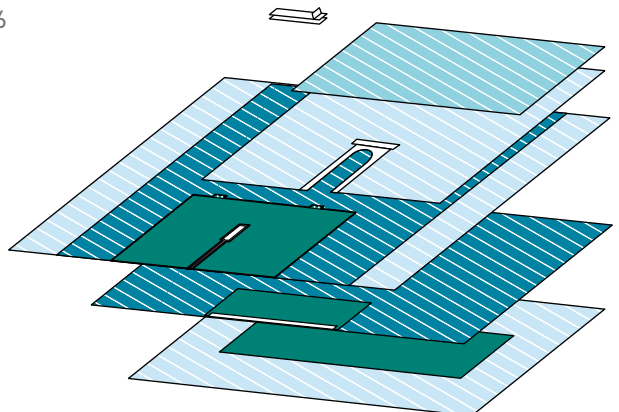

**EXTREMITY DRAPE**

**825200**

11/22

958252 230x315 cm, aperture 7 cm elastic

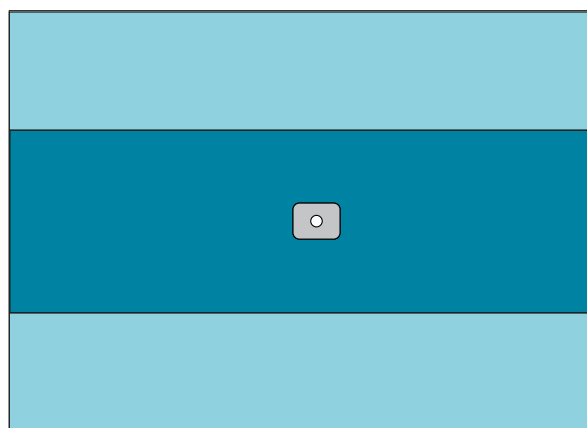

**EXTREMITY DRAPE**

**825400** 950255 230x315 cm, aperture 7cm elastic, patch 70x100 cm, wrapped

9/18

**825500** 950255 230x315 cm, aperture 7cm elastic, patch 70x100 cm

9/18

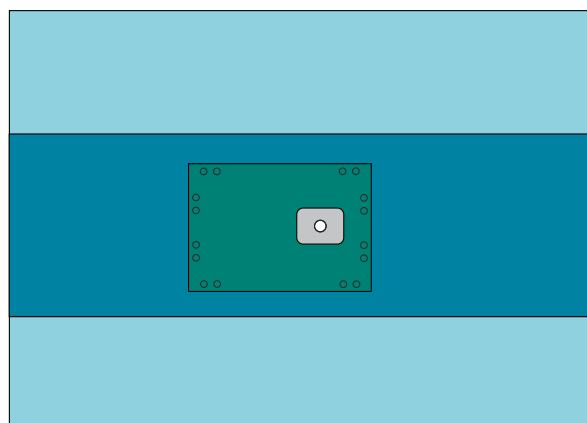

**HAND/FOOT DRAPE**

**903294** 950252 150x180 cm, aperture 3,5 cm elastic, patch 70x70 cm

10/40

**825600** 950256 230x315 cm, aperture 3,5 cm elastic, patch 70x70 cm

10/20

**825605** 950256 230x315 cm, aperture 3,5 cm elastic, patch 70x70 cm, wrapped

10/20

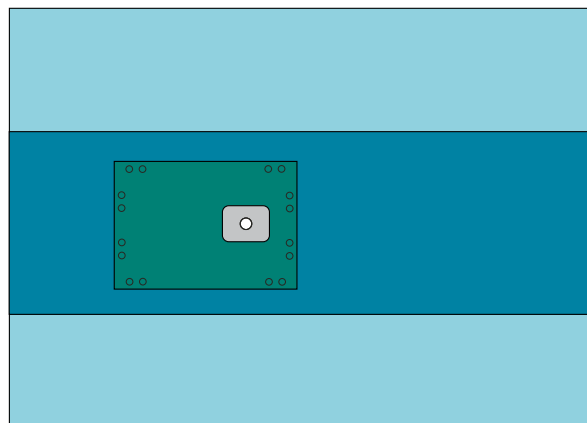

**KNEE ARTHROSCOPY DRAPE**

**825900**

8/16

958259 230x320 cm, aperture 5 cm elastic



**VERTICAL ISOLATION DRAPE**

<b>826010</b>	815300	330x240 cm, incise area 25x86 cm	10/20
<b>826020</b>	815301	330x240 cm, incise area 30x40 cm	10/20

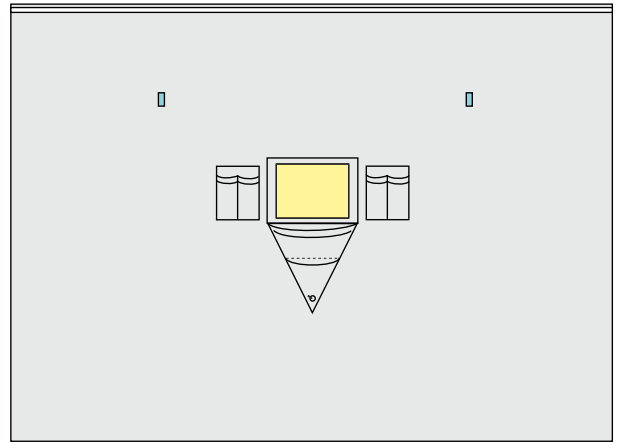

**EXTREMITY DRAPE**

**261**

/11

9261

146/376x297 cm, reinforcement 46x86 cm, aperture 3 cm, elastic, wrapped

/16

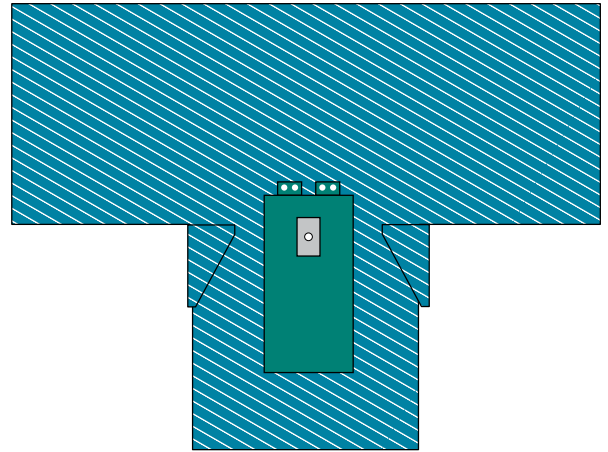

**EXTREMITY DRAPE**

**270**

/11

9270

257x320 cm, reinforcement 91x122 cm, aperture 6,5 cm, elastic, wrapped

/14

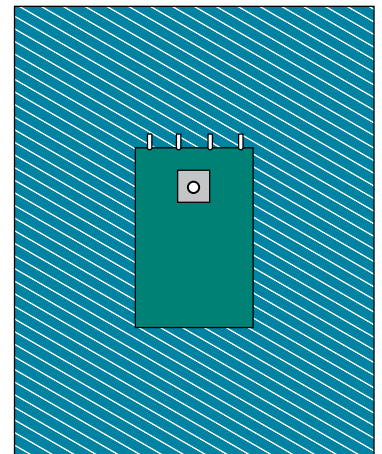

**ARTHROSCOPY DRAPE W/ POUCH**

**278**

/12

9568

257x305 cm, aperture 6 cm, elastic, wrapped

/16

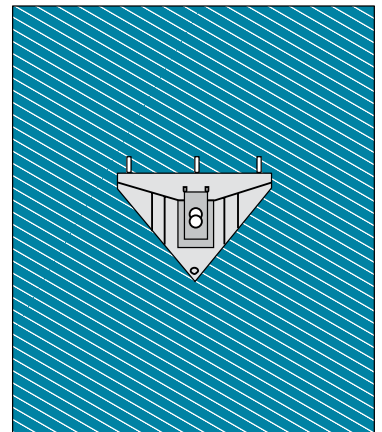

**BEACH CHAIR SHOULDER DRAPE**

**294**

/10

9294

257x406 cm, aperture 15x15 cm, elastic, wrapped

/10

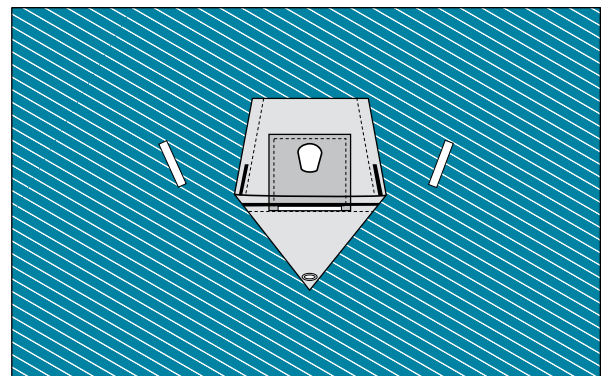

**HIP DRAPE**

**1260** /13

9904 208x295 cm, reinforcement 91.5x152 cm, aperture 18x22 cm, elastic, wrapped /14

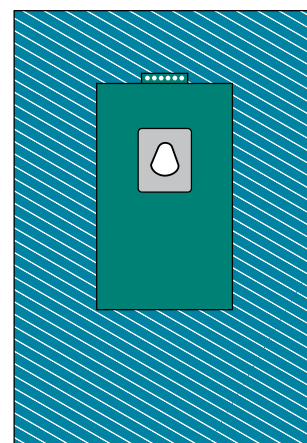

**EXTREMITY DRAPE W/ HINGE**

**1261** /13

9867 208x300 cm, reinforcement 61x122 cm, aperture 6 cm, elastic, wrapped /20

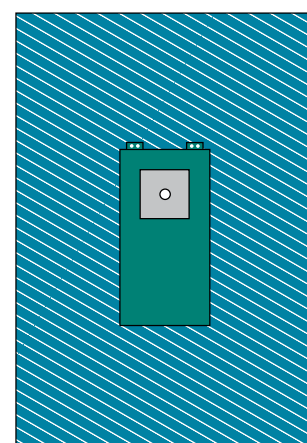

**BILATERAL EXTREMITY DRAPE**

**1265** /12

9902 208x295 cm, reinforcement 91.5x90 cm, apertures 6 cm, elastic, wrapped /16

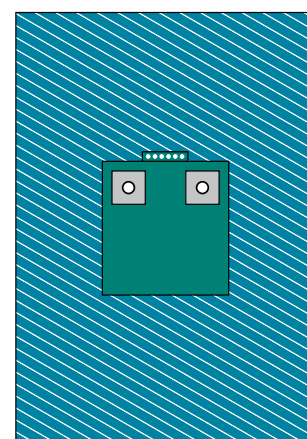

**EXTREMITY DRAPE**

**1271** /12

9671 206/256x320 cm, reinforcement 61x122cm, aperture 6 cm, elastic, wrapped /16

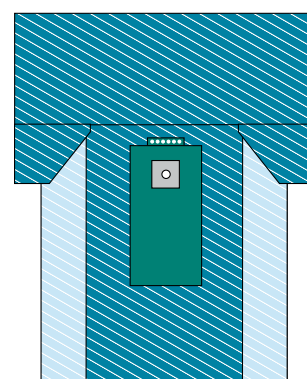

**HIP DRAPE W/ SIDE POCKETS**

**2040**

/8

9202 223x282/322 cm, reinforcement 61x160 cm, aperture 18x22 cm, elastic, wrapped

/10

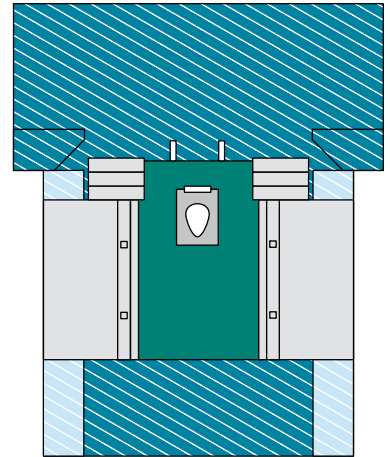

**VERTICAL ISOLATION DRAPE**

**5222**

/15

9914 218x320 cm, reinforcement 81x40 cm, incise area 35x23 cm, wrapped

/27

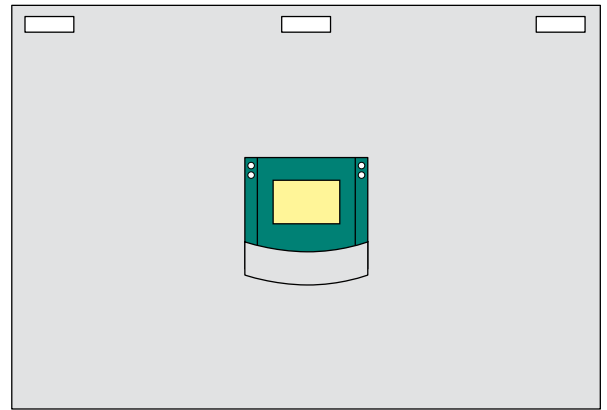

**FOOT EXTREMITY DRAPE**

**8000528**

/10

80008029 183x296 cm, reinforcement 75x91.5 cm, aperture 5 cm, elastic, wrapped

/17

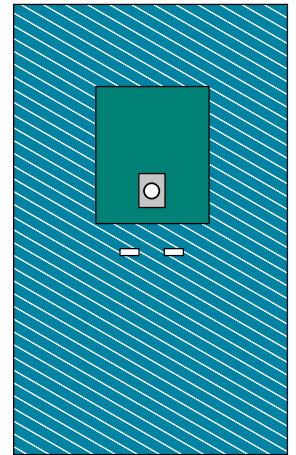

**VERTICAL ISOLATION DRAPE**

**8000527**

/12

80008032 240x320 cm, incise area 30x60 cm, wrapped

/15

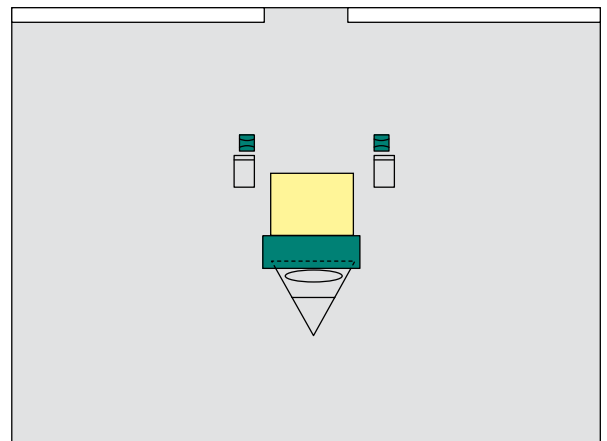

**HAND EXTREMITY DRAPE**

**80005140** /30

9924 150x240 cm, aperture 6 cm, elastic, wrapped /30

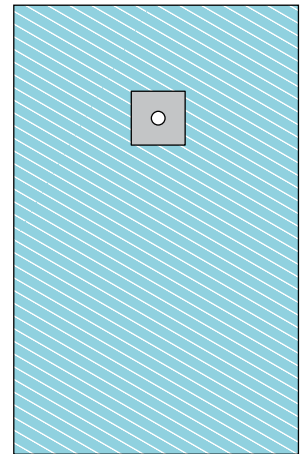

**HAND EXTREMITY DRAPE**

**80005291** /6

924126 146/380x296 cm, reinforcement 45x125 cm, aperture 2.5 cm, elastic, wrapped /12

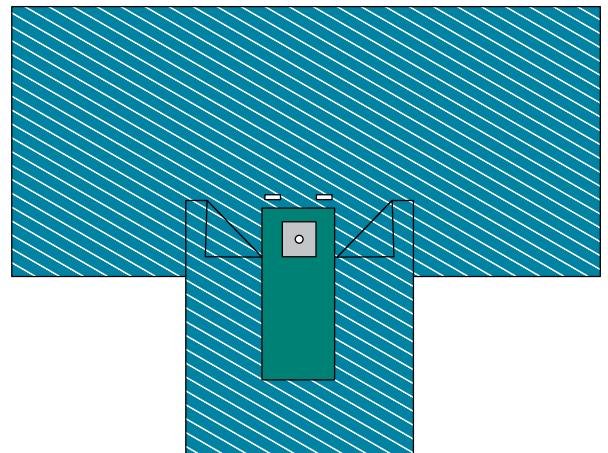

**EXTREMITY DRAPE**

**80097435** /10

80008021 183x296 cm, reinforcement 91.5x100cm, aperture 5 cm, elastic, wrapped /150

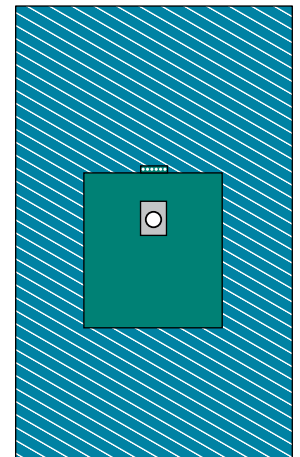

**BILATERAL EXTREMITY DRAPE**

**84551201** /14

- 208x295 cm, reinforcement 91.5x90 cm, aperture 6.5 cm, elastic, wrapped /14

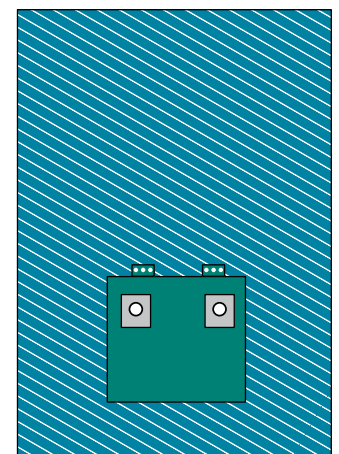

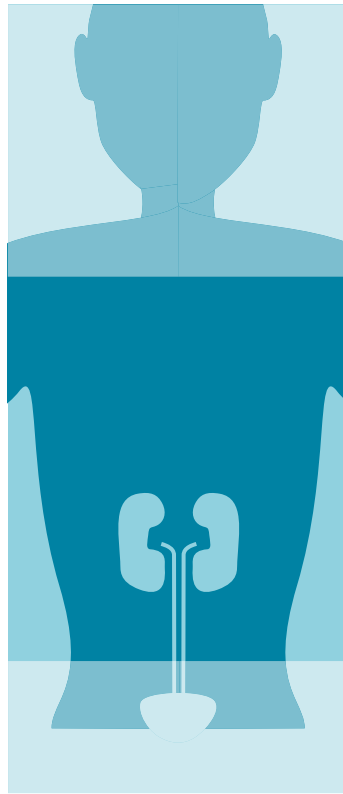

## UROLOGY SETS AND DRAPES



**TUR SET**

**696310**

10/20

- 911510 1 op-tape 9x49 cm
- 906109 2 leggings 75x120 cm
- 910225 1 tur drape 75x175 cm, apertures 8 cm and 6 cm, finger cot
- 914080 1 table cover 150x190 cm, 75x190 cm absorbent

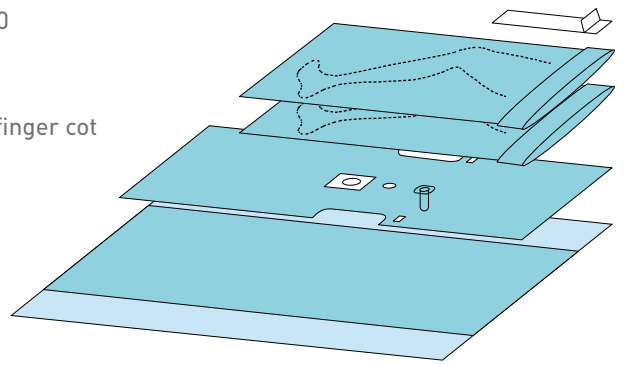

**TUR SET**

**888222**

6/12

- 1 cellulose towel 19x25 cm
- 904762 1 tube holder 9x18 cm
- 965520 1 tur drape 175x215 cm w/ pouch, apertures 8 cm and 5 cm, finger cot
- 914080 1 table cover 150x190 cm, 75x190 cm absorbent

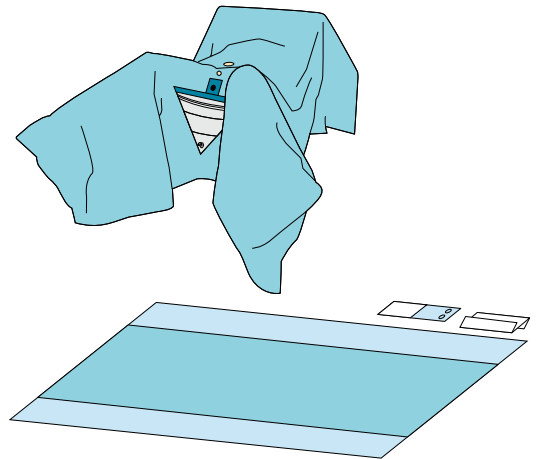

**TUR SET**

**888224**

6/12

- 1 cellulose towel 19x25 cm
- 904762 1 tube holder 9x18 cm
- 965522 1 tur drape 175x215 cm w/ pouch/trunk, apertures 8 cm and 5 cm, finger cot
- 914080 1 table cover 150x190 cm, 75x190 cm absorbent

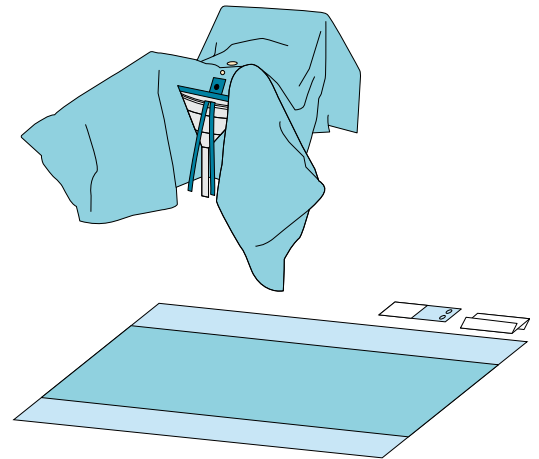

**TUR SET**

**888225**

7/14

- 1 cellulose towel 19x25 cm
- 904762 1 tube holder 9x18 cm
- 965525 1 tur drape 175x215 cm w/ sieve, apertures 8 cm and 5 cm, finger cot
- 914080 1 table cover 150x190 cm, 75x190 cm absorbent

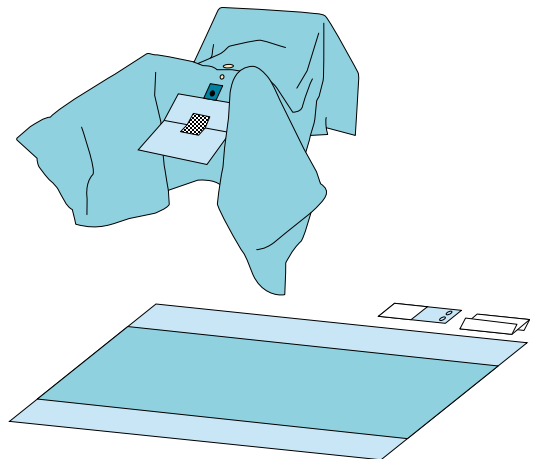

## TUR SET

903810

10/20

- 911510 3 op-tape 9x49 cm
- 1 utility drape 75x80 cm
- 906109 2 leggings 75x120 cm
- 900038 1 tur drape 100x230 cm w/ sieve,  
aperture 5x9 cm, finger cot
- 1 table cover 150x140 cm, 75x140 cm absorbent

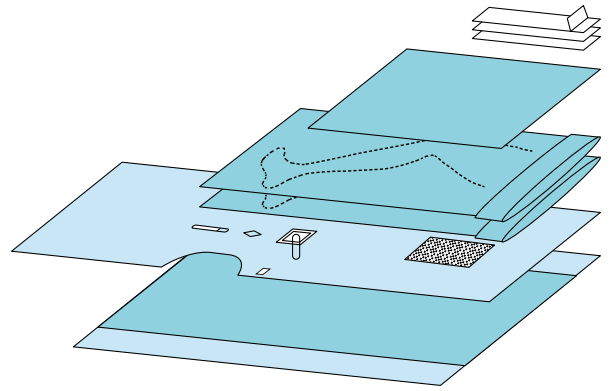

**CYSTOSCOPY SET I**

1220

/12

- 9755 2 lithotomy leggings 69x122 cm
- 9523 1 cystoscopy drape w/ sieve 104/146x221 cm, reinforcement 46x102 cm, aperture 9x18 cm
- 9845 1 table cover 140x180 cm, 66x180 cm absorbent

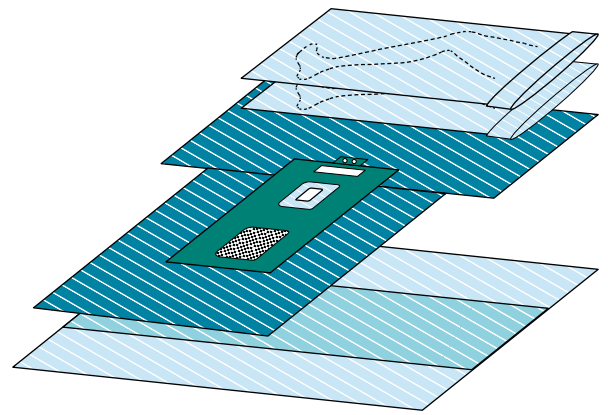

**CYSTOSCOPY SET II**

1222

/9

- 9222 1 cystoscopy drape w/sieve 146/253x274 cm, reinforcement 30/46x105 cm, aperture 6x15cm
- 9845 1 table cover 140x180 cm, 66x180 cm absorbent

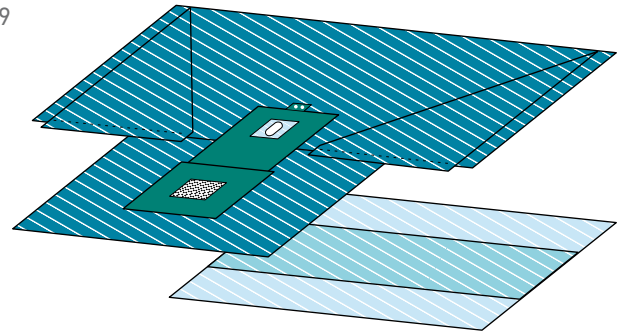

**CYSTOSCOPY SET II**

1223

/8

- 1 handtowel 50x50 cm
- 770301 1 urology gown L
- 10 sponges 10x10 cm
- 9755 2 lithotomy leggings 69x122 cm
- 1 cellulose towel 50x50 cm
- 9523 1 cystoscopy drape w/Sieve 104/146x221 cm, reinforcement 46x102 cm, aperture 9x18 cm
- 9845 1 table cover 140x180 cm, 66x180 cm absorbent

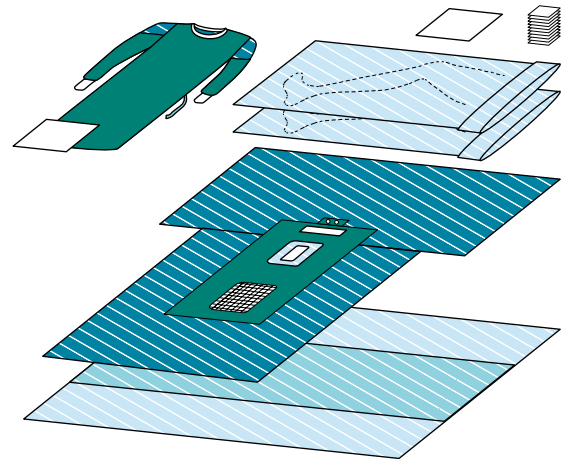

**TUR SET**

80011621

/7

- 80008019 1 TUR drape w/pouch and Finger cot 257/160x211 cm, apertures 5cm
- 80008022 1 table cover 140x180 cm, 66x180 cm absorbent

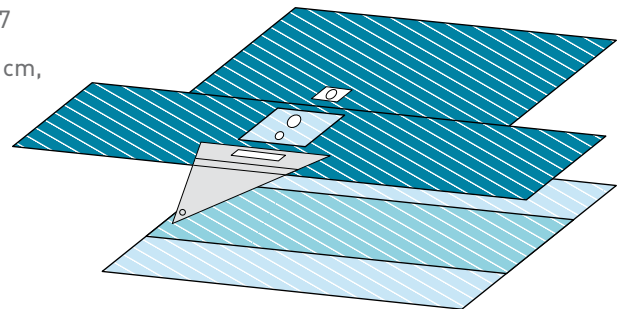

**TUR SET**

**80974511**

/10

- 9755 2 lithotomy leggings 69x122 cm
- 9917 1 TUR drape w/Finger cot 79/146x202cm, aperture 5cm
- 1 wrap 107x107 cm

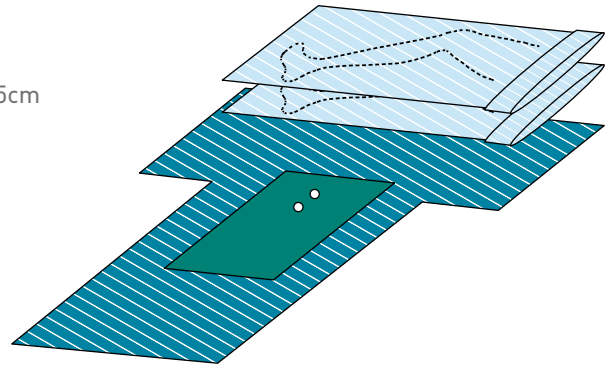

**NEPHROSCOPY DRAPE W/ POUCH**

1221

/12

9912 183x302 cm, apertured incise 5 cm, wrapped

/11

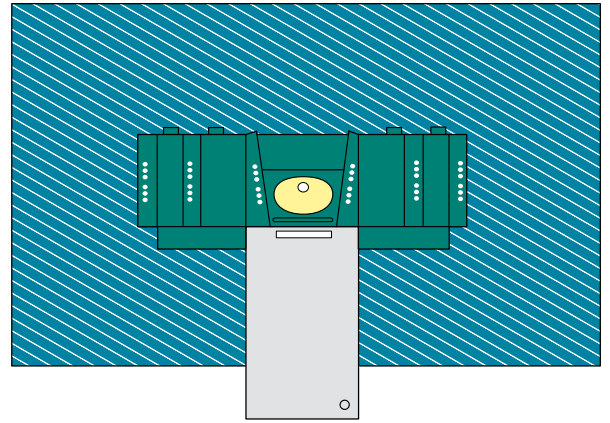

**TUR DRAPE**

80051321

/8

80008019 257/160x211 cm, apertures 5cm, pouch and finger cot, wrapped

/85

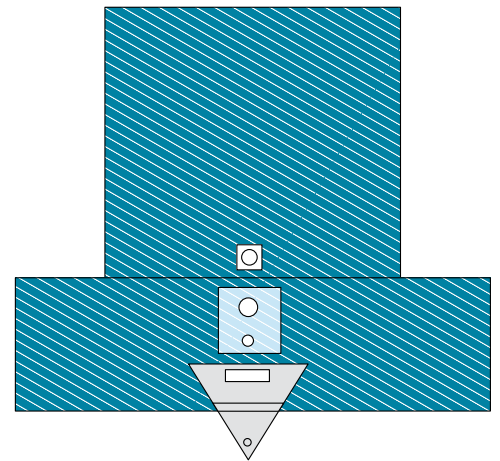

**RECTAL DRAPE**

84521220

/40

- 60x85 cm, aperture 5,5x8 cm, finger cot

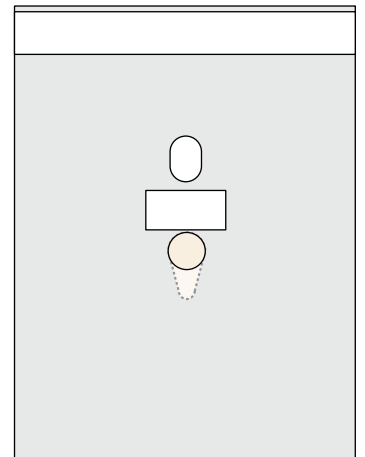

## **UNCOMPROMISING COMPLEMENTS WHEN IT IS NEEDED**

In a number of cases, single packed products are needed as a complement during surgery. For that purpose BARRIER offers a wide range of single-use solutions such as mayo stand covers, table covers, incise drapes and pouches.

Equipment such as microscopes, probes, cameras, C-arms, etc can be difficult and sometimes impossible to sterilise. BARRIER offers a full range of sterile, transparent drapes and provides an efficient infection control without compromising the use of instruments.



## **SUPPLEMENTARIES TO DRAPES**

**MAYO STAND COVER**

**610601**

25/75

996106

79x145 cm, 65x85 cm absorbent

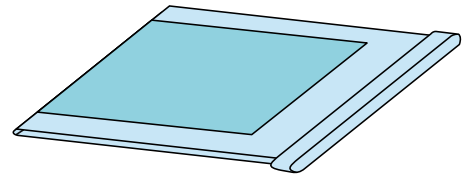

---

**MAYO STAND COVER**

**610900**

20/60

996109

reinforced 79x145 cm, 65x85 cm absorbent

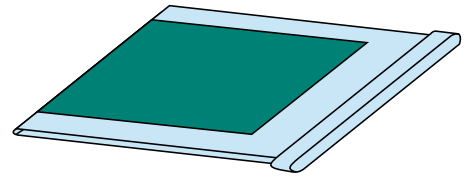



MAYO STAND COVER

<b>144</b>	9144	69x142 cm, 66x76 cm absorbent, wrapped	/36	/70
<b>1244</b>	9544	58x137 cm, 45x56 cm absorbent, wrapped	/96	/90
	954430			/1920

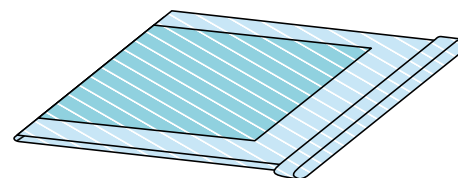

MAYO STAND COVER REINFORCED

<b>80000552</b>	8046	reinforced, 79x145 cm, 61x85 cm absorbent, wrapped	20/40	/735
<b>80062681</b>	8046	reinforced, 79x145 cm, 61x85 cm absorbent	20/60	/735

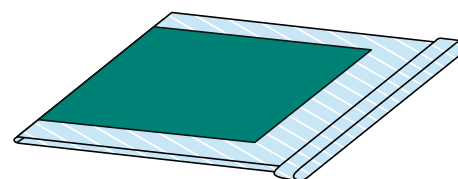

MAYO STAND COVER

		<b>80062671</b>	25/75
8083	79x145 cm, 65x85 cm absorbent		/1050

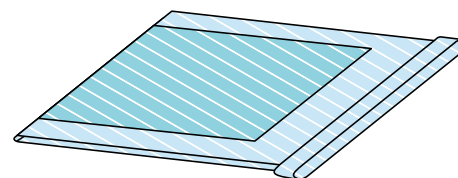

TABLE COVER LARGE

780300

10/20

978030 290x330 cm, 80x150 cm absorbent

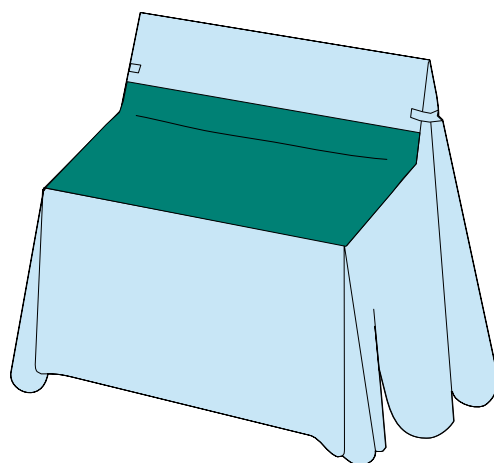

TABLE COVER

807800	948078	150x160 cm, 75x160 cm absorbent	28/56
807900	-	100x150 cm, 75x150 cm absorbent	40/80
808000	-	150x190 cm, 100x190 cm absorbent	22/44
808005	-	150x190 cm, 100x190 cm absorbent, wrapped	20/40
808105	-	150x240 cm, 100x240 cm absorbent, wrapped	16/32



TABLE COVER

808800

15/30

968088 200x280 cm, absorbent

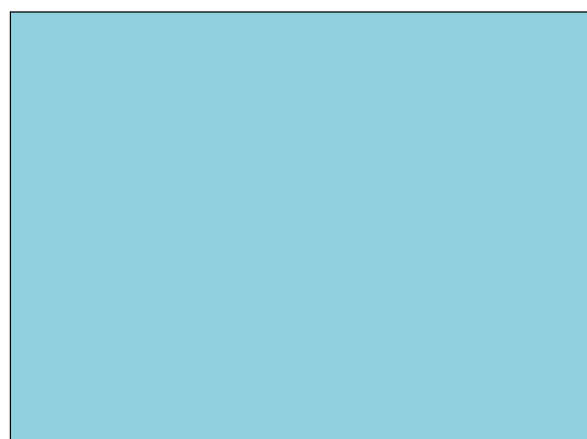

TABLE COVER

809005	948090	reinforced 150x190 cm, 65x190 cm absorbent, wrapped	15/30
809105	978091	reinforced 150x240 cm, 65x240 cm absorbent, wrapped	13/26



TABLE COVER

<b>260</b>	9660	140x215 cm, 66x215 cm absorbent, wrapped	20/40	/30
<b>80006263</b>	8106	140x215 cm, 66x215 cm absorbent	20/40	/62
<b>80062601</b>	8045	140x150 cm, 66x150 cm absorbent	30/60	/100
<b>84532021</b>	-	140x140 cm, 66x140 cm absorbent, wrapped	25/50	
<b>84532041</b>	80008022	140x180 cm, 66x180 cm absorbent, wrapped	22/44	/70

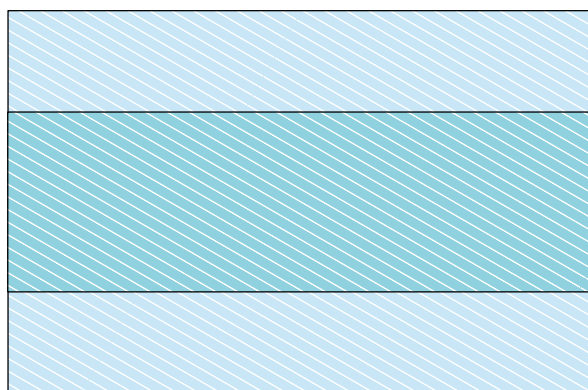
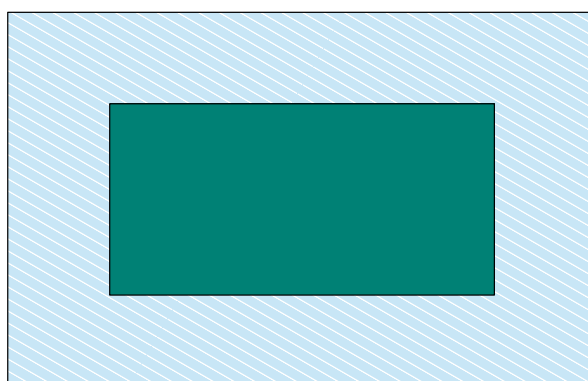

TABLE COVER REINFORCED

<b>264</b>	9376	reinforced 178x280 cm, 91x183 cm absorbent, wrapped	/20	/30
<b>266</b>	930324	reinforced 140x215 cm, 61x152 cm absorbent, wrapped	/22	/30



OVERHEAD TABLE DRAPE

	<b>290</b>		/20	
9290		203x213 cm, 91x122 cm absorbent, wrapped	/20	

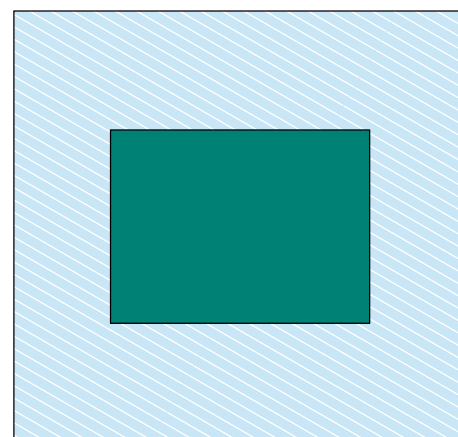

IMPERVIOUS DRAPE SHEET

	<b>84532081</b>		/50	
930329		140x180 cm, wrapped	/60	

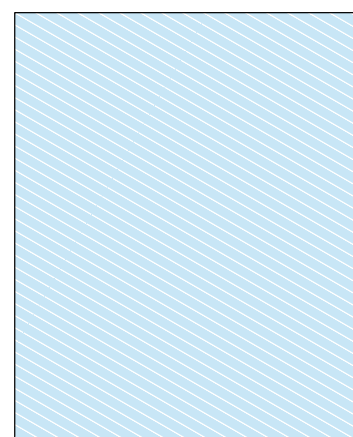

INCISE DRAPE

<b>80001014</b>	80008008	10x14 (10x8) cm	40/160	/1500
<b>80001526</b>	80008105	15x26 (15x20) cm	30/120	/1000
<b>80003026</b>	8008009	30x26 (30x20) cm	25/100	/350
<b>80004040</b>	80008106	40x40 (40x34) cm	20/80	/180
<b>80004526</b>	80008107	45x26 (45x20) cm	20/80	/150
<b>80004555</b>	80008010	45x55 (45x49) cm	15/60	/280
<b>80005680</b>	80008011	56x80 (56x74) cm	10/40	/300

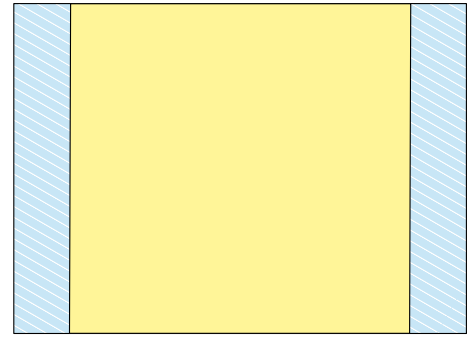

**INSTRUMENT POCKET**

**705860**

15/30

815320 30x50 cm

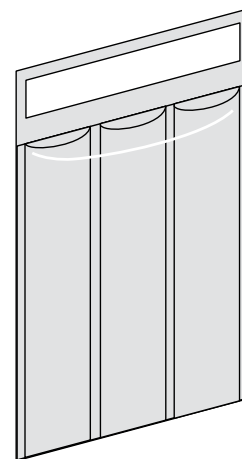

**FLUID COLLECTION BAG**

**706035**

30/120

976035 40x35 cm

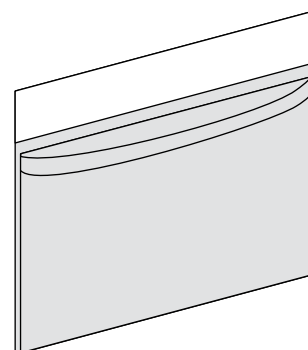

**SUCTION AND DIATHERMY BAG**

**707035**

30/120

977035 40x35 cm

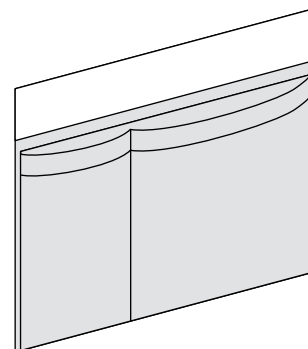

**IRRIGATION POUCH**

**831200**

12/24

815310 50x50 cm

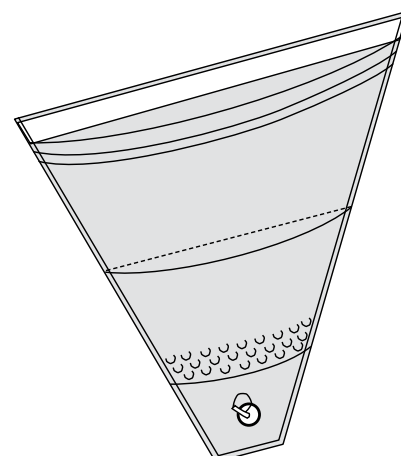

**KNEE ARTHROSCOPY POUCH**

**831400**

5/10

815311 60x120 cm, aperture 5cm elastic

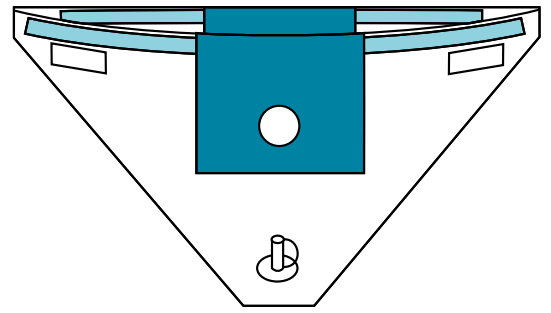

**INCISE POUCH**

**832000**

11/22

983200 100x80 cm, incise area 38x32 cm

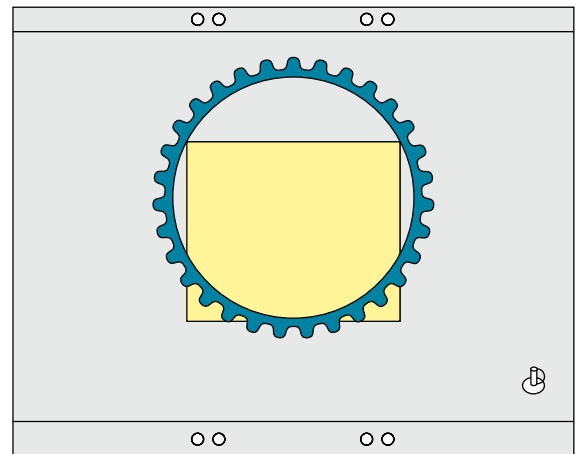

**FLUID COLLECTION POUCH**

**5217**

/24

9317 83x88 cm, split 15x52 cm, wrapped

/30

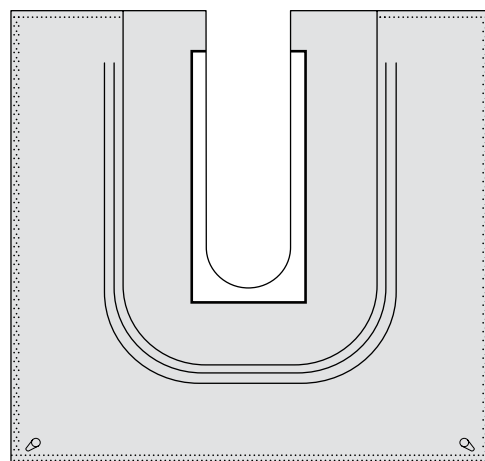

**IRRIGATION POUCH**

**5218**

20/40

- 60x120 cm, aperture 5cm elastic

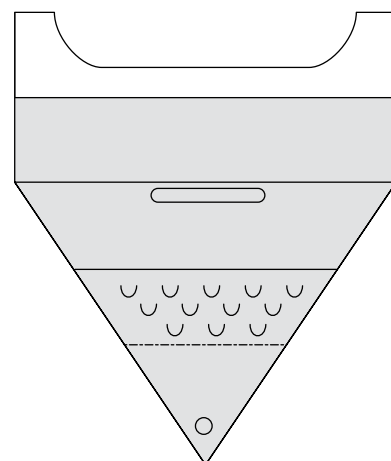

**TUBE POCKET**

**80003113**

/40

8183 90x96 cm, absorbent 70x50 cm, wrapped

/100

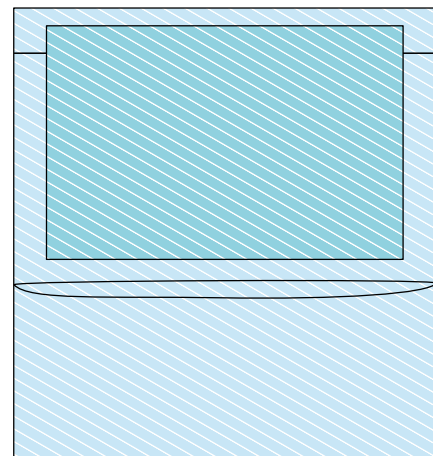

**LAPAROSCOPY POUCH**

**80004128**

/50

- 29x48 cm, wrapped

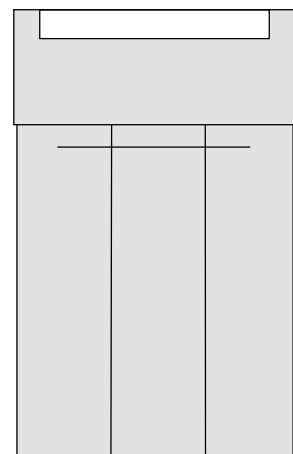

**DIATHERMY POUCH**

**80454103** /40

80008041 30x40 cm, wrapped

/300

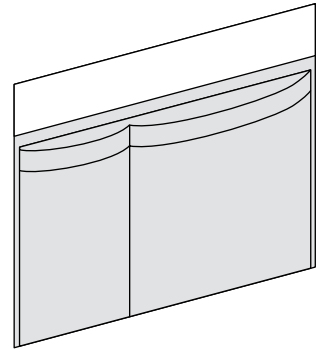

**DISLOCATION BAG**

**84541230** /80

922709 75x120 cm, wrapped

/100





## TUBE/CAMERA DRAPE

815330 8x120 cm, plain tip

705740

30/120

/200

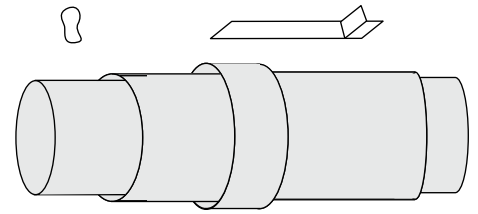

## TUBE/CAMERA DRAPE

815331 15x250 cm, plain tip

705750

20/80

/100

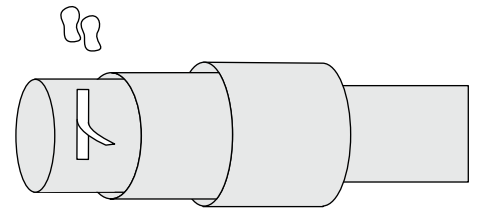

## CAMERA DRAPE

705820 815332 75x120 cm, wrapped

15/60

/100

80004130 80008034 14x254 cm, perforated tip,  
wrapped

25/50

/100

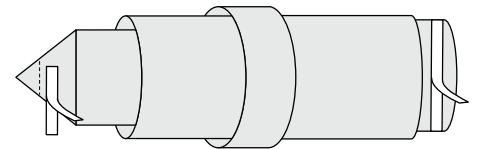

## CAMERA DRAPE

705830 815333 18x246 cm, elastic tip

15/60

/100

80000549 80008033 18x244 cm, elastic tip,  
wrapped

30/120

/100

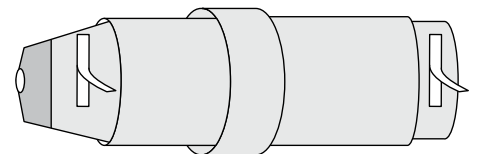

## CAMERA DRAPE

<b>705835</b>	815334	13x250 cm, cardboard inserter	18/36	/100
<b>84541211</b>	80008035	14x254 cm, cardboard inserter, wrapped	40/	/100

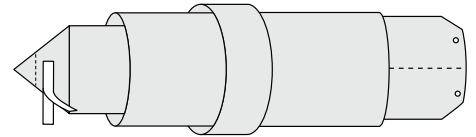

## CAMERA DRAPE

	<b>705837</b>		24/96	
815335		15x254 cm, with ring inserter		/100

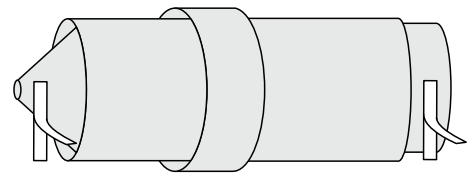

## CAMERA DRAPE

<b>705840</b>	815350	circular 150 cm	10/20	/50
<b>705841</b>	815351	circular 75 cm	10/40	/100
<b>903740</b>	990374	circular 90 cm	28/168	/160
<b>903757</b>	990375	circular 140 cm	16/96	/100
<b>84541240</b>	-	circular 90 cm, wrapped	/60	-

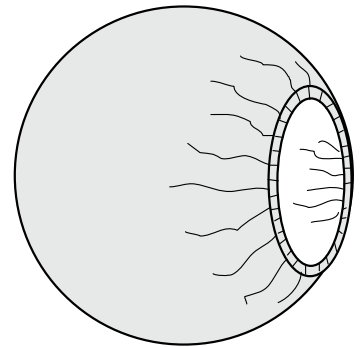

## CAMERA DRAPE

<b>705844</b>	815353	square 75x75 cm	8/32	/100
<b>705845</b>	815354	rectangular 75x90 cm	7/28	/100

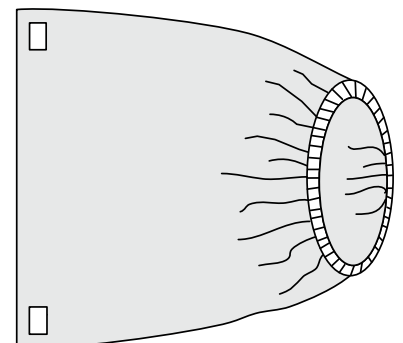

**C-ARM DRAPE****705850**

10/20

815360 1-part half coverage 117x183 cm

/50

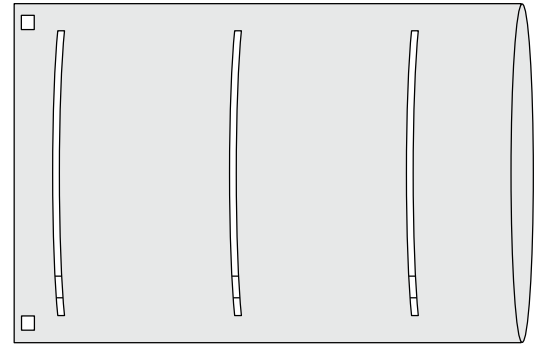
**C-ARM DRAPE****705852**

9/18

815361 1-part full coverage 152x265 cm

/50

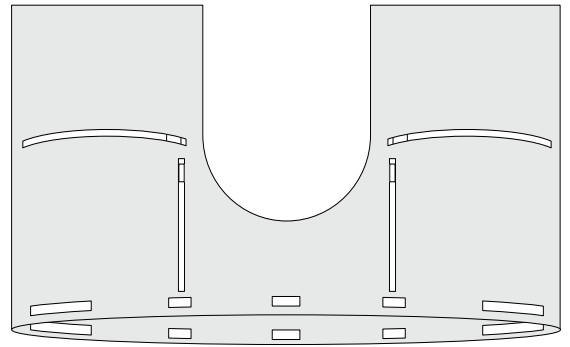
**C-ARM DRAPE****80006233**

/26

906233 Siemens 2-part, wrapped

/30

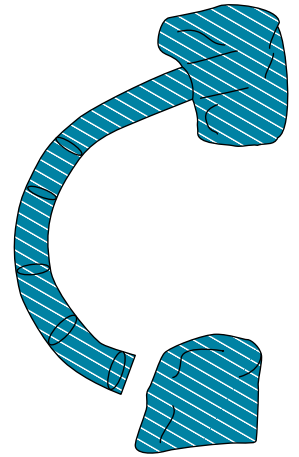
**C-ARM DRAPE****80006234**

/26

906234 Philips 3-part, wrapped

/30

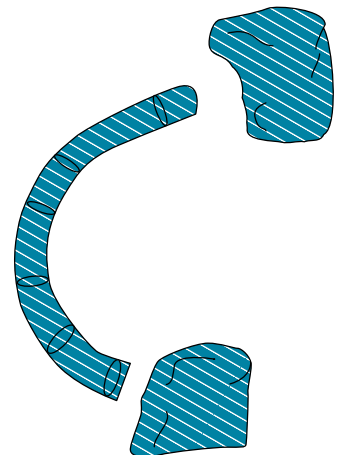

## MICROSCOPE DRAPE

<b>705920</b>	815431	Flexible elastic lens, 117x254 cm	9/18	/50
<b>705930</b>	815402	WILD (objective 68mm), 117x165 cm	8/16	/50
<b>705936</b>	815403	WILD (objective 68mm) 117x254 cm	7/14	/50
<b>705943</b>	815404	WILD (objective 68mm) 117x305 cm	7/14	/50
<b>705947</b>	815405	WILD M680 w/ angled lens 137x304 cm	4 /16	/50

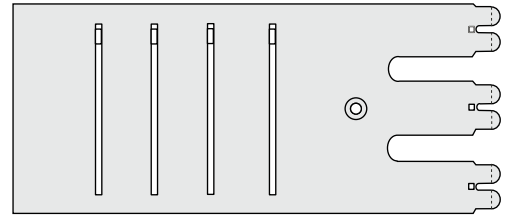

## MICROSCOPE DRAPE

<b>705950</b>	815411	Zeiss MD (objective 65mm) 117x165 cm	8/16	/50
<b>705955</b>	815412	Zeiss MD (objective 65mm) 117x254 cm	7/14	/50
<b>705960</b>	815413	Zeiss OPMI (objective 48mm) 117x165 cm	7/14	/50
<b>705970</b>	815423	Zeiss OPMI (objective 48mm) 117x165 cm	9/18	/50
<b>705980</b>	815424	Zeiss OPMI (objective 48mm) 117x254 cm	8/16	/50

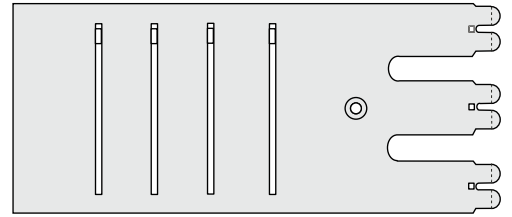

## MICROSCOPE DRAPE

		<b>705974</b>	12/24	
	815421	Zeiss OPMI (objective 48mm) simple slim 50x165 cm		/50

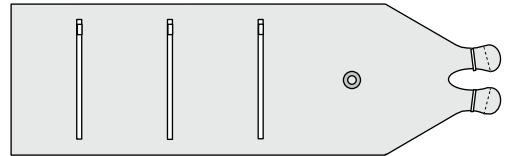

## MICROSCOPE DRAPE

		<b>705975</b>	9/18	
	815422	Zeiss OPMI (objective 48mm) slim 50/117x165 cm		/50

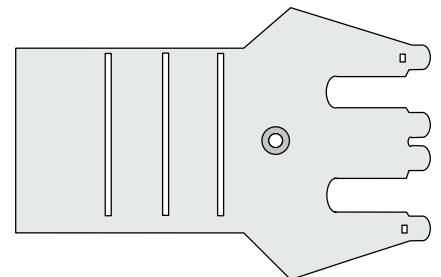

**ULTRA SOUND PROBE DRAPE****706000**

20/80

815340 13x236 cm, burr hole

/100

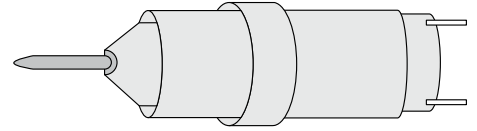
**ULTRA SOUND PROBE DRAPE****706002**

20/80

815342 15x236 cm, small T-tip

/100

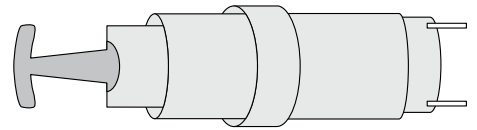
**ULTRA SOUND PROBE DRAPE****706004**

20/80

815344 13x236 cm, straight tip

/100

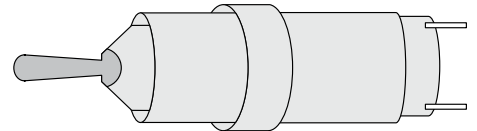
**X-RAY CASSETTE DRAPE****705856**

815362

60x60 cm

25/50

/100

**84542040**

-

60x75 cm, wrapped  
wrapped

/40

/100

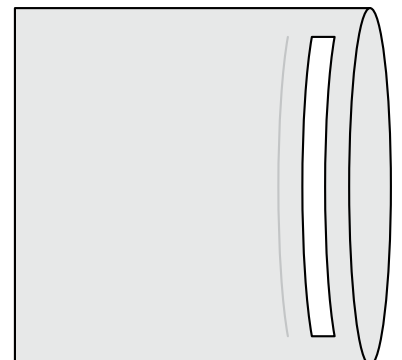

ARMREST DRAPE

8008062 35x73 cm, 2 pcs

80002120

/80

/300

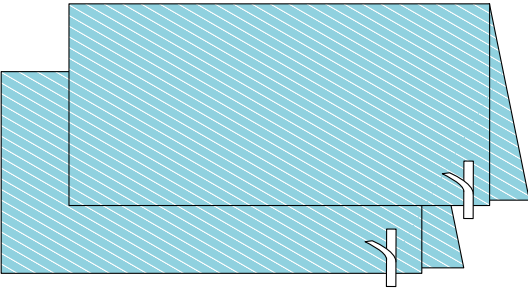

**OP-TAPE**

**381030**

100/400

911510 9x49 cm

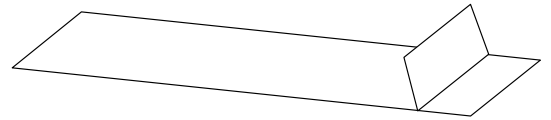

---

**OP-TAPE 2 PCS-PACK**

**381040**

120/480

911510 9x49 cm

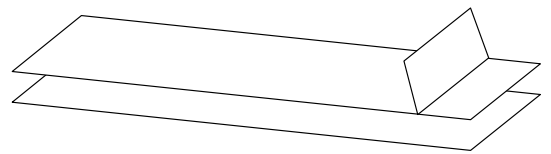

**LITHOTOMY LEGGINGS 2 PCS-PACK**

610930

30/60

906109 75x120 cm

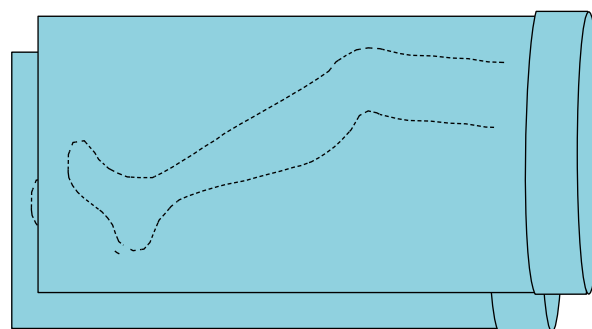

**LITHOTOMY LEGGINGS 2 PCS-PACK**

901680

64/128

- 75x115 cm

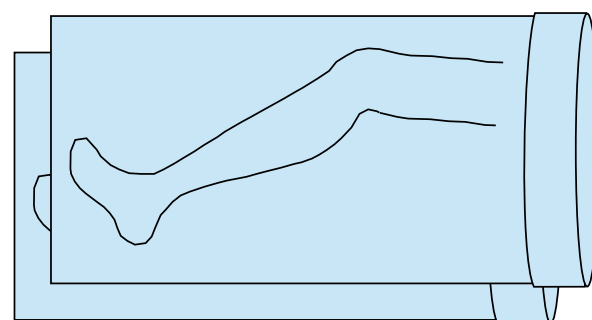

**STOCKINET**

611105 946111 small, 22x75 cm  
611205 946112 large, 32x120 cm

22/132  
20/40

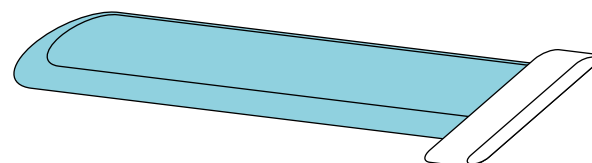

**KLINIPLAST (NON-STERILE)**

700300	-	40x45 cm	/450
700400	-	45x70 cm	/300
700500	-	70x90 cm	/200
700501	-	70x90 cm, folded	/150
700600	-	90x90 cm	/150
700601	-	90x90 cm, folded	/150
700700	-	90x130 cm	/100
700701	-	90x130 cm, folded	/100

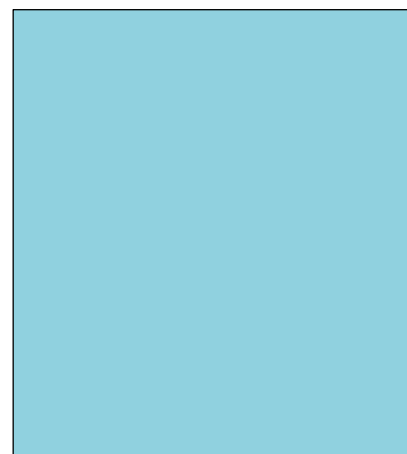



**KLINIPLAST (NON-STERILE)**

702200 - roll, 90 cmx50 m 50/200  
 702400 - roll, 90 cmx200 m /200

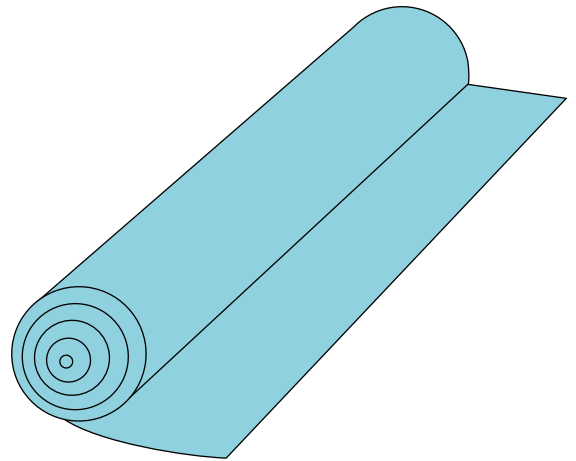

**TUBE HOLDER VELCRO**

708131 50/200

824098 2,5x30 cm

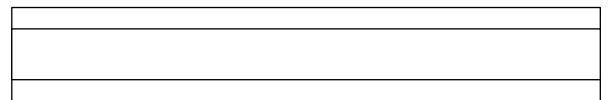

**OP-HANDTOWEL (NON-STERILE)**

748140 30/300

- 37x40 cm

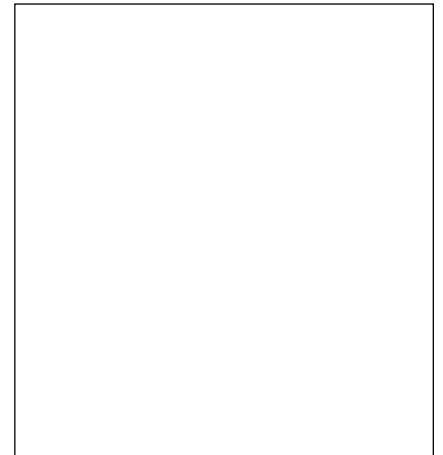

**GENITAL COVER**

903153 50/100

- 18x40 cm

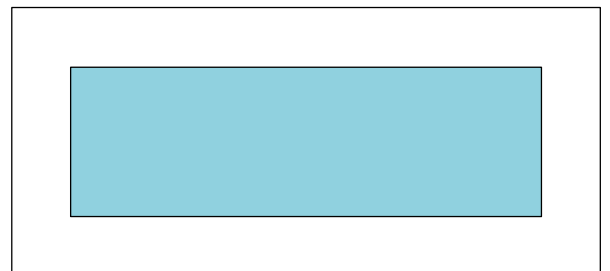

---

**FEET SOCKS TRANSPARENT 2 PCS-PACK**

**691005**

130/260

991005 36x28 cm

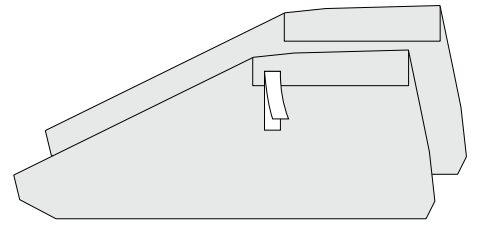

**HANDTOWEL**

<b>245</b>	-	50x50 cm, 4pcs, wrapped	/336
<b>8000004</b>	-	50x50 cm, 2pcs, wrapped	/180

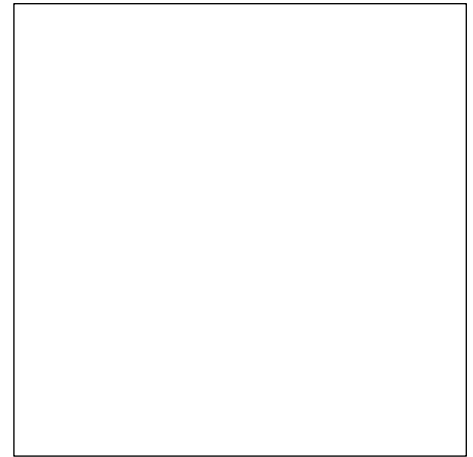

**LITHOTOMY LEGGINGS 2 PCS-PACK**

9855	79x152 cm, wrapped
------	--------------------

**255**

/54  
/110

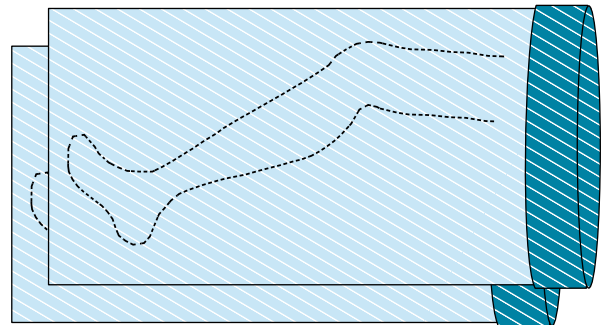

**STOCKINET**

<b>269</b>	8008060	23x71 cm, wrapped	/48	/128
<b>272</b>	-	18x86 cm, wrapped	/30	
<b>273</b>	9056	23x107cm, wrapped	/18	/90
<b>274</b>	9057	31x122 cm, wrapped	/15	/90

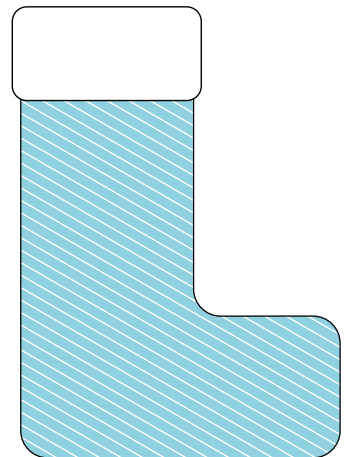

**OP-TAPE**

		<b>6073</b>	100/400
8081	9x50 cm		/2400

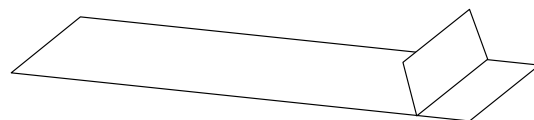

**STOCKINET**

<b>5220</b>	-	8x51 cm, 2 pcs, plastic	200/400	
<b>6072</b>	8081	9x50 cm, 2 pc	120/180	/2400
<b>84541050</b>	-	8x45 cm, 2 pcs, plastic, wrapped	50/100	

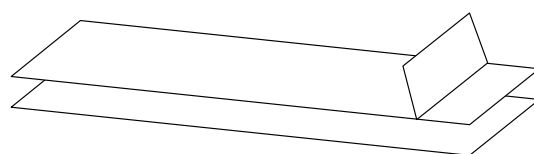

**CORD HOLDERS**

		<b>80006076</b>	60/240
8008064	5x15 cm		/500



**ABSORBENT TOWEL**

		<b>84357150</b>	/200
9931	34x53 cm, 2 pcs, wrapped		/380

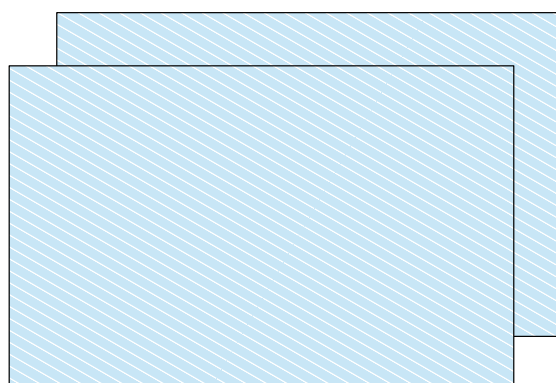

**ABSORBENT TOWEL**

**84357160** /50

923720 80x100 cm, wrapped

/80

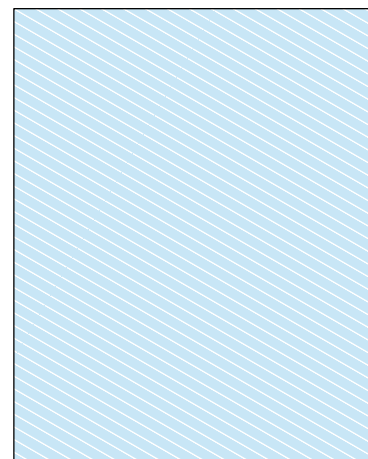

**STOCKINET**

**86530880** 45/270

8078 32x88cm w/OP-TAPE

/300

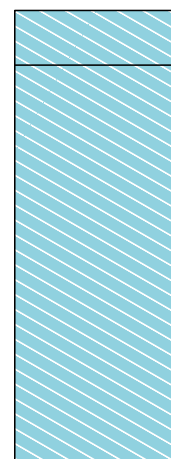

**PREP PAD (NON-STERILE)**

**213** /50

- 61x102 cm

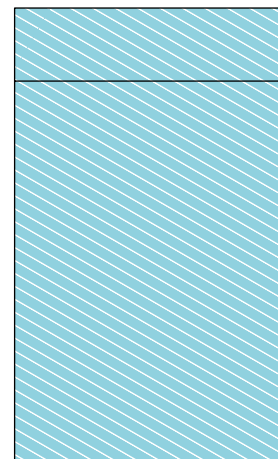

## **NEW BARRIER GOWNS DESIGNED TO LET YOU PERFORM AT THE HIGHEST LEVEL**

Surgical gowns not only prevent infection of the surgical wound. They must also protect the operating team from liquid contamination.

BARRIER surgical gowns offer different levels of protection, covering the needs of less invasive operations with fluid repellent material to wet surgery with plastic reinforced front, impermeable sleeves and seams. The toughest conditions can be met with a gown that is impermeable all over.

A new level of comfort and personal protection.

- The new BARRIER surgical gown range is the widest and most comprehensive range of advanced single-use surgical gowns
- Ergonomically tailored for improved freedom of movement
- Easy-access sterile packaging with easy to follow labelling

BARRIER surgical gowns also provide a high level of personal comfort with high breathability and air permeability.

**TIE-BACK SURGICAL GOWN - BASIC**

<b>640101</b>	two towels, wrapped	L	20/40
<b>640102</b>	one towel, no wrapping	L	22/44
<b>640103</b>	one towel, no wrapping	XL-L	20/40
740101	no towels, no wrapping, non sterile	L	/52
740103	no towels, no wrapping, non sterile	XL-L	/42

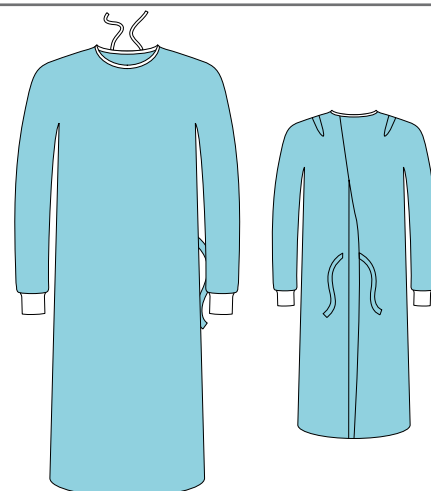

**SURGICAL GOWN - STANDARD**

<b>650101</b>	two towels, wrapped	M	20/40
<b>650102</b>	two towels, wrapped	L	20/40
<b>650104</b>	two towels, wrapped	L-L	20/40
<b>650105</b>	no towels, no wrapping	L-L	22/44
<b>650106</b>	two towels, wrapped, thumb loop	L-L	18/36
<b>650108</b>	two towels, wrapped	XL	18/36
<b>650116</b>	no towels, no wrapping	XL	20/40
<b>650110</b>	two towels, wrapped	XL-L	18/36
<b>650111</b>	no towels, no wrapping	XL-L	18/36
<b>650113</b>	two towels, wrapped	XXL-XL	16/32
<b>650114</b>	two towels, wrapped	XXL-L	18/36
<b>650115</b>	no towels, no wrapping	XXL-L	18/36
750101	no towels, no wrapping, non sterile	M	/54
750102	no towels, no wrapping, non sterile	L	/46
750103	no towels, no wrapping, non sterile	L-L	/298
750104	no towels, no wrapping, non sterile	L-L	/46
750105	two towels, wrapped, non sterile	L-L	/248
750106	no towels, no wrapping, thumb loop, non sterile	L-L	/280
750108	no towels, no wrapping, non sterile	XL	/42
750110	no towels, no wrapping, non sterile	XL-L	/42
750111	no towels, no wrapping, non sterile	XL-L	/262
750115	two towels, wrapped, non sterile	XL-L	/208
750113	no towels, no wrapping, non sterile	XXL-XL	/36
750114	no towels, no wrapping, non sterile	XXL-L	/36

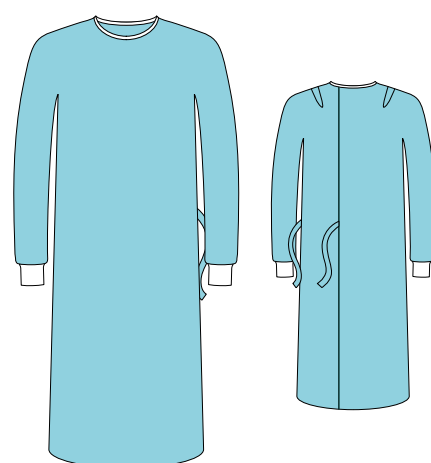

**SURGICAL GOWN WITH BAVETTE - STANDARD**

<b>650107</b>	two towels, wrapped	L-L	20/40
750107	no towels, no wrapping, non sterile	L-L	/46

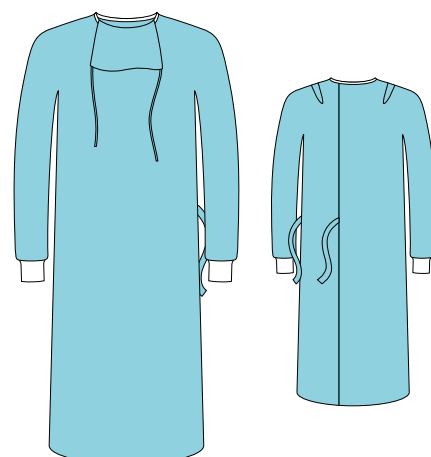

SURGICAL GOWNS IN MULTIPACK - STANDARD

<b>650103</b>	two towels, wrapped	2 x L	10/20
<b>650109</b>	two towels, wrapped	2 x XL	10/20

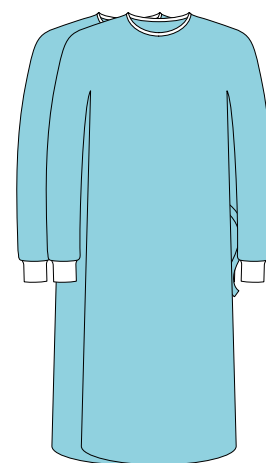

SURGICAL GOWNS IN MULTIPACK - STANDARD

<b>650112</b>	no towels, wrapped	2 x XL-L + 1 x L-L	6/12
<b>650117</b>	no towels, wrapped	2 x XXL-L + 1 x XL	6/12

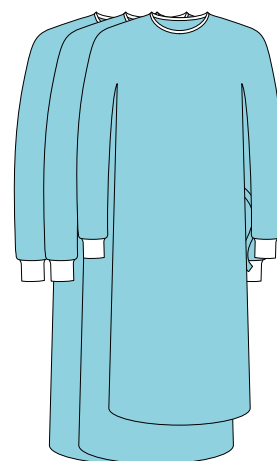

FABRIC REINFORCED SURGICAL GOWN - STANDARD

<b>650130</b>	two towels, wrapped	XL	16/32
<b>650131</b>	two towels, wrapped	XL-L	16/32

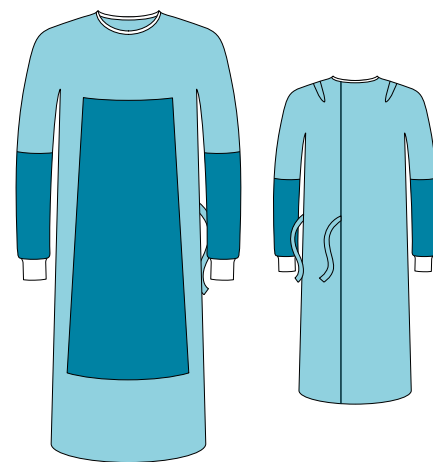

SURGICAL GOWN II - STANDARD

<b>650201</b>	two towels, wrapped	M	24/48
<b>650202</b>	two towels, wrapped	L	24/48
<b>650203</b>	two towels, wrapped	L-L	24/48
<b>650204</b>	two towels, wrapped	XL	24/48
<b>650205</b>	two towels, wrapped	XL-L	22/44
<b>650206</b>	two towels, wrapped	XXL-XL	20/40
<b>650207</b>	two towels, wrapped	XXL-L	20/40
750201	no towels, no wrapping, non sterile	M	/66
750202	no towels, no wrapping, non sterile	L	/66
750203	no towels, no wrapping, non sterile	L-L	/58
750204	no towels, no wrapping, non sterile	XL	/54
750205	no towels, no wrapping, non sterile	XL-L	/42
750206	no towels, no wrapping, non sterile	XXL-XL	/42
750207	no towels, no wrapping, non sterile	XXL-L	/40

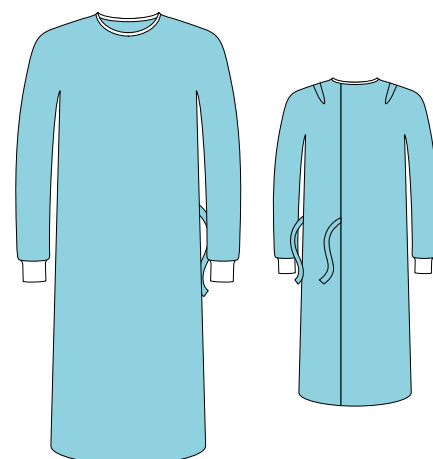



REINFORCED SURGICAL GOWN - SPECIAL

<b>660101</b>	two towels, wrapped	L	18/36
<b>660102</b>	two towels, wrapped	L-L	18/36
<b>660103</b>	no towels, no wrapping	L-L	18/36
<b>660105</b>	two towels, wrapped	XL	16/32
<b>660113</b>	no towels, no wrapping	XL	18/36
<b>660106</b>	two towels, wrapped	XL-L	18/32
<b>660107</b>	no towels, no wrapping	XL-L	18/36
<b>660110</b>	two towels, wrapped	XXL-XL	16/32
<b>660111</b>	two towels, wrapped	XXL-L	16/32
<b>660112</b>	no towels, no wrapping	XXL-L	16/32
760101	no towels, no wrapping, non sterile	L	/46
760102	no towels, no wrapping, non sterile	L-L	/46
760103	no towels, no wrapping, non sterile	L-L	/228
760105	no towels, no wrapping, non sterile	XL	/34
760106	no towels, no wrapping, non sterile	XL-L	/34
760107	no towels, no wrapping, non sterile	XL-L	/209
760110	no towels, no wrapping, non sterile	XXL-XL	/190
760111	no towels, no wrapping, non sterile	XXL-L	/34

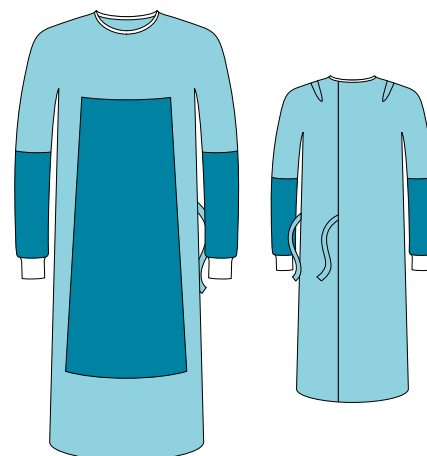

REINFORCED SURGICAL GOWN WITH BAVETTE - SPECIAL

<b>660104</b>	two towels, wrapped, thumb loop	L-L	16/32
<b>660108</b>	two towels, wrapped, thumb loop	XL-L	16/32
760104	no towels, no wrapping, non sterile	L-L	/42
760108	no towels, no wrapping, non sterile	XL-L	/34

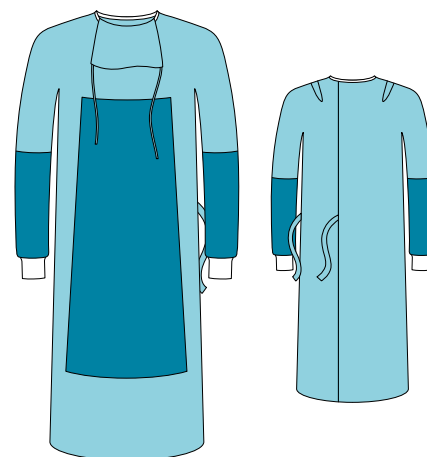

REINFORCED SURGICAL GOWNS IN MULTIPACK - SPECIAL

<b>660109</b>	no towels, wrapped	2 x XL-L + 1 x L-L	6/12
<b>660114</b>	no towels, wrapped	2 x XXL-L + 1 x XL	6/12

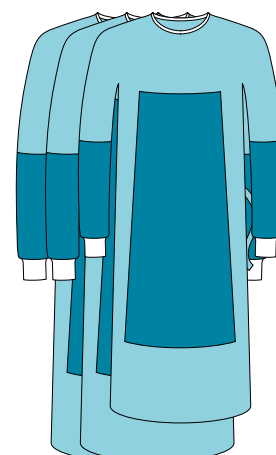

LAMINAR FLOW SURGICAL GOWN - EXTRA

660201 two towels, wrapped XL-L 16/32

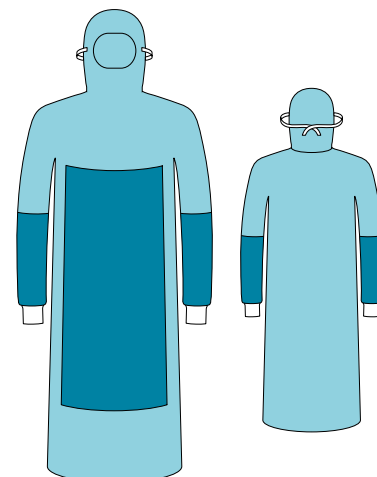

REINFORCED SURGICAL GOWN II - SPECIAL

660201	two towels, wrapped	M	22/44
660202	two towels, wrapped	L	22/44
660203	two towels, wrapped	L-L	20/40
660204	two towels, wrapped	XL	20/40
660205	two towels, wrapped	XL-L	18/36
660206	two towels, wrapped	XXL-XL	18/36
660207	two towels, wrapped	XXL-L	18/36
760201	no towels, no wrapping, non sterile	M	/56
760202	no towels, no wrapping, non sterile	L	/52
760203	no towels, no wrapping, non sterile	L-L	/50
760204	no towels, no wrapping, non sterile	XL	/44
760205	no towels, no wrapping, non sterile	XL-L	/40
760206	no towels, no wrapping, non sterile	XXL-XL	/36
760207	no towels, no wrapping, non sterile	XXL-L	/38

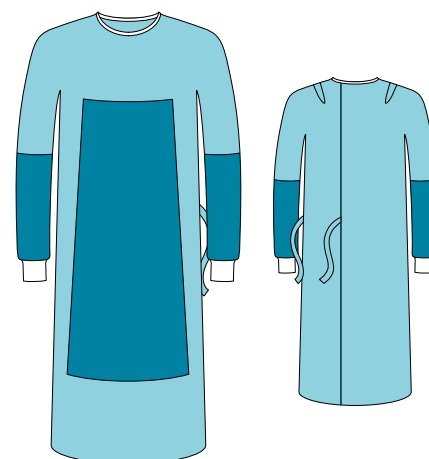

FLUID PROTECTION PLUS SURGICAL GOWN - EXTRA

670101	two towels, wrapped	M	32/64
670102	two towels, wrapped	L	32/64
670103	two towels, wrapped	L-L	30/60
670104	two towels, wrapped	XL	28/56
670105	two towels, wrapped	XL-L	28/56
670106	two towels, wrapped	XXL-XL	28/56
670107	two towels, wrapped	XXL-L	26/52
770101	no towels, no wrapping, non sterile	M	/74
770102	no towels, no wrapping, non sterile	L	/72
770103	no towels, no wrapping, non sterile	L-L	/68
770104	no towels, no wrapping, non sterile	XL	/62
770105	no towels, no wrapping, non sterile	XL-L	/62
770106	no towels, no wrapping, non sterile	XXL-XL	/50
770107	no towels, no wrapping, non sterile	XXL-L	/52

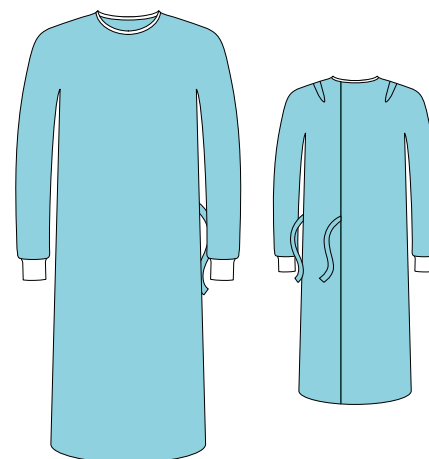

UROLOGY GOWN - EXTRA

670301	two towels, wrapped	L	22/44
670302	two towels, wrapped	XL	22/44
770301	no towels, no wrapping, non sterile	L	/56
770302	no towels, no wrapping, non sterile	XL	/50

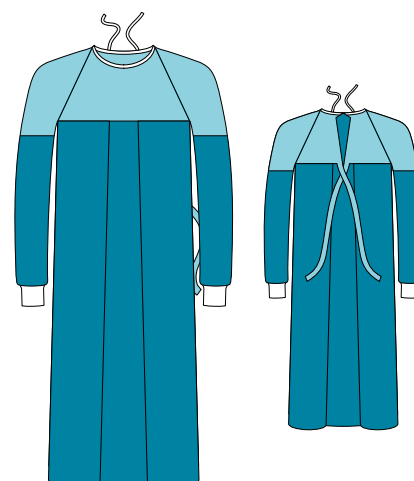

**ARM SLEEVE**

623501

962350 non sterile

30/180  
/420

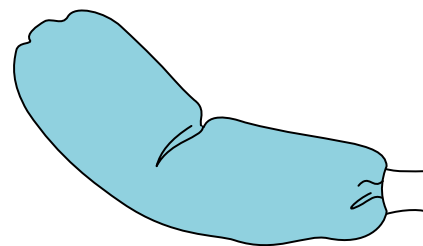

**SURGICAL GOWN LIGHT**

98000622  
98000623  
98000624  
98000625

two towels, wrapped  
two towels, wrapped  
two towels, wrapped  
two towels, wrapped

L  
L-L  
XL  
XL-L

/34  
/32  
/32  
/30

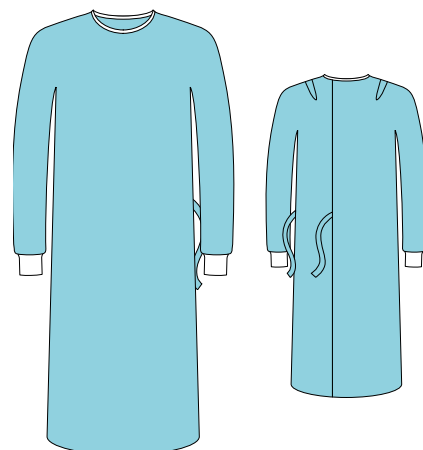

**SURGICAL GOWN LIGHT REINFORCED**

98000722  
98000723  
98000724  
98000725

two towels, wrapped  
two towels, wrapped  
two towels, wrapped  
two towels, wrapped

L  
L-L  
XL  
XL-L

/30  
/28  
/28  
/26

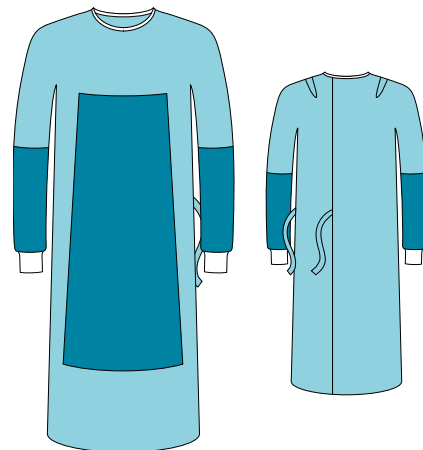

## **WHAT YOU WEAR CLOSE TO YOUR SKIN NEEDS TO BE FRESH AND COMFORTABLE**

BARRIER offers a range of single use scrub suits and warm-up jackets that provide the comfort and quality of wearing fresh clothes every day. The scrub suit range has modern designs and four quality levels; basic, standard, special and unisoft. Warm-up jackets provide additional comfort and warmth when needed.

The BARRIER clean air suit reduces the flow of skin carrying bacteria from wearer to the theatre air. The ideal solution for infection prone procedures and operations on immune compromised patients.

SCRUB SUIT - BASIC

<b>836100</b>	top and trousers	blue	S	/30
<b>836200</b>	top and trousers	blue	M	/30
<b>836300</b>	top and trousers	blue	L	/30
<b>836400</b>	top and trousers	blue	XL	/30



SCRUB SUIT - BASIC

<b>836125</b>	top	green	S	/30
<b>836225</b>	top	green	M	/30
<b>836325</b>	top	green	L	/30
<b>836425</b>	top	green	XL	/30
<b>836126</b>	trousers	green	S	/30
<b>836226</b>	trousers	green	M	/30
<b>836326</b>	trousers	green	L	/30
<b>836426</b>	trousers	green	XL	/30



SCRUB SUIT - STANDARD

<b>837125</b>	top with comfort zone	green	S	/30
<b>837225</b>	top with comfort zone	green	M	/30
<b>837325</b>	top with comfort zone	green	L	/30
<b>837425</b>	top with comfort zone	green	XL	/30
<b>837126</b>	trousers with comfort zone	green	S	/30
<b>837226</b>	trousers with comfort zone	green	M	/30
<b>837326</b>	trousers with comfort zone	green	L	/25
<b>837426</b>	trousers with comfort zone	green	XL	/25



SCRUB SUIT - SPECIAL

<b>838125</b>	top with comfort zone and cuff	green	S	/30
<b>838225</b>	top with comfort zone and cuff	green	M	/30
<b>838325</b>	top with comfort zone and cuff	green	L	/30
<b>838425</b>	top with comfort zone and cuff	green	XL	/30
<b>838126</b>	trousers with comfort zone and cuff	green	S	/30
<b>838226</b>	trousers with comfort zone and cuff	green	M	/30
<b>838326</b>	trousers with comfort zone and cuff	green	L	/25
<b>838426</b>	trousers with comfort zone and cuff	green	XL	/25



SCRUB SUIT - SCRUB SHIRT - UNISOFT

18610	scrub shirt	green	S	12/48
18620	scrub shirt	green	M	12/48
18630	scrub shirt	green	L	12/48
18640	scrub shirt	green	XL	12/48
18650	scrub shirt	green	2XL	12/48
18660	scrub shirt	green	3XL	12/48
18670	scrub shirt	green	4XL	12/48

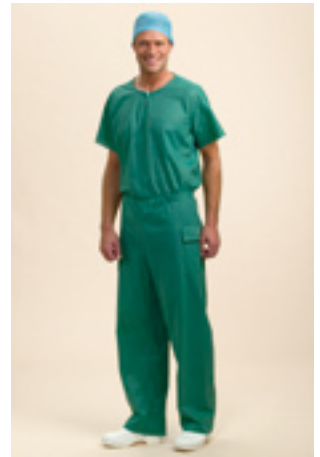

SCRUB SUIT - DRAWSTRING PANTS - UNISOFT

18710	drawstring pants	green	S	12/48
18720	drawstring pants	green	M	12/48
18730	drawstring pants	green	L	12/48
18740	drawstring pants	green	XL	12/48
18750	drawstring pants	green	2XL	12/48
18760	drawstring pants	green	3XL	12/48
18770	drawstring pants	green	4XL	12/48



SCRUB SUIT - NURSES BLOUSE - UNISOFT

18820	nurses blouse	green	S	12/48
18830	nurses blouse	green	M	12/48
18840	nurses blouse	green	L	12/48
18850	nurses blouse	green	XL	12/48
18860	nurses blouse	green	2XL	12/48

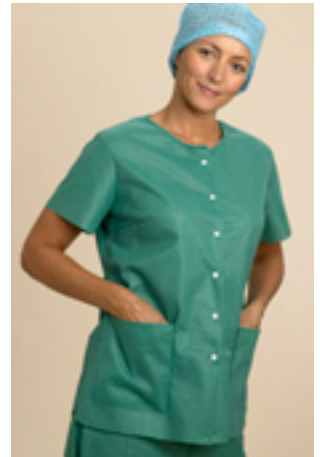

SCRUB SUIT - WOMEN'S ELASTIC WAIST SLACKS - UNISOFT

18920	women's elastic waist slacks	green	S	12/48
18930	women's elastic waist slacks	green	M	12/48
18940	women's elastic waist slacks	green	L	12/48
18950	women's elastic waist slacks	green	XL	12/48
18960	women's elastic waist slacks	green	2XL	12/48

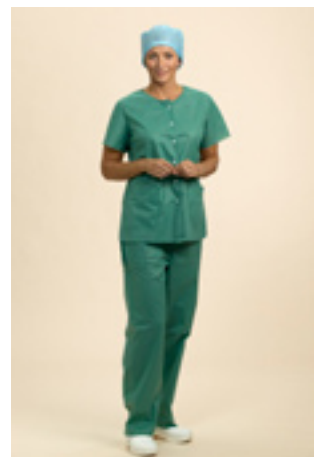

WARM-UP JACKET

1801	warm-up jacket	blue	M	12/24
1802	warm-up jacket	blue	L	12/24
1803	warm-up jacket	blue	XL	12/24



WARM-UP JACKET - UNISOFT

18001	warm-up jacket	green	S	12/48
18010	warm-up jacket	green	M	12/48
18020	warm-up jacket	green	L	12/48
18030	warm-up jacket	green	XL	12/48
18040	warm-up jacket	green	2XL	12/48
18050	warm-up jacket	green	3XL	12/48

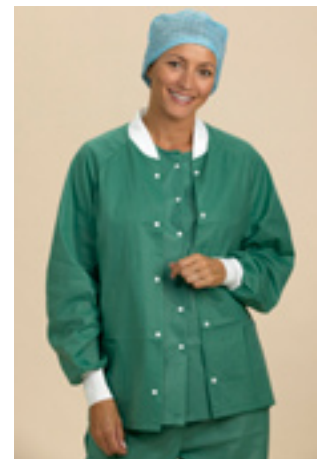

EXTRA PROTECTION WARM-UP JACKET - LONG - UNISOFT

18200	extra Protection Warm-up jacket	green	S	12/48
18210	extra Protection Warm-up jacket	green	M	12/48
18220	extra Protection Warm-up jacket	green	L	12/48
18230	extra Protection Warm-up jacket	green	XL	12/48
18240	extra Protection Warm-up jacket	green	2XL	12/48
18250	extra Protection Warm-up jacket	green	3XL	12/48

WARM-UP JACKET MEDIUM SLEEVE - UNISOFT

18300	warm-up jacket medium sleeve	green	S	12/48
18310	warm-up jacket medium sleeve	green	M	12/48
18320	warm-up jacket medium sleeve	green	L	12/48
18330	warm-up jacket medium sleeve	green	XL	12/48
18340	warm-up jacket medium sleeve	green	2XL	12/48



CLEAN AIR SUIT

<b>835100</b>	1-piece	blue	S	/25
<b>835200</b>	1-piece	blue	M	/25
<b>835300</b>	1-piece	blue	L	/20
<b>835400</b>	1-piece	blue	XL	/20

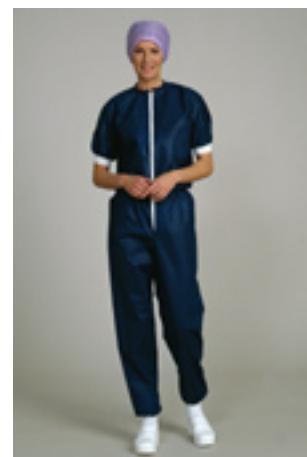

CLEAN AIR SUIT

<b>834110</b>	top with comfort zone	blue	S	/20
<b>834210</b>	top with comfort zone	blue	M	/20
<b>834310</b>	top with comfort zone	blue	L	/20
<b>834410</b>	top with comfort zone	blue	XL	/20
<b>834510</b>	trousers	blue	S	/30
<b>834610</b>	trousers	blue	M	/30
<b>834710</b>	trousers	blue	L	/30
<b>834810</b>	trousers	blue	XL	/30

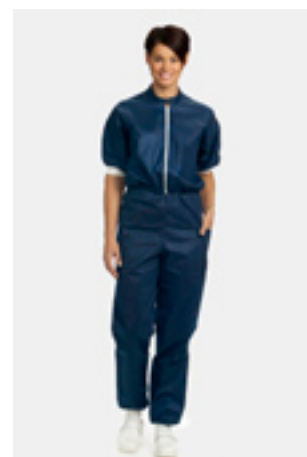



## A SAFE CHOICE

All types of foreign body represent a potential risk of infection in the operating wound. Therefore it is of critical importance that the clothing of the operating team actually covers the body parts that pose the greatest risk. The head - and especially the hair - is one of these parts.

BARRIER offers a wide range of headwear in different styles and fits, covering requirements for any type of operation, any shape and size of head and any hairstyle.

**BASIC CAP, ANNIE**

621500	elastic	mixed colours	L (55 cm)	150/600
621715	elastic	blue	M (50 cm)	150/600
621725	elastic	green	M (50 cm)	150/600
621735	elastic	white	M (50 cm)	150/600
621825	elastic	green	L (55 cm)	150/600
621835	elastic	white	L (55 cm)	150/600
621925	elastic	green	XL (60 cm)	150/600



**BASIC CAP, ANNIE PRO**

621845	elastic, sweat band	green	L (55 cm)	120/480
--------	---------------------	-------	-----------	---------



**BASIC CAP, CHARLOTTE**

620900	elastic	white	M (50 cm)	/200
620910	elastic	blue	M (50 cm)	/200
620920	elastic	green	M (50 cm)	/200



**STANDARD CAP, TUCK**

620100	tie-band	green	one-size	100/500
620105	tie-band	blue	one-size	100/500



**STANDARD CAP, JACK**

620300      tailored fit      green      one-size      100/500



**STANDARD CAP, FLORY**

620500      tie-band      green/white      one-size      100/500



**STANDARD CAP, EUROCAP**

620800      flexible fit      blue      one-size      100/500  
 620810      flexible fit      green      one-size      100/500



**STANDARD CAP, KOSACK**

621000      elastic      green      one-size      100/500  
 621001      elastic      violet      one-size      100/500  
 621005      elastic      blue      one-size      100/500



**STANDARD CAP, KOSACK C**

621010	elastic	green	one-size	100/500
621020	elastic	blue	one-size	100/500



**STANDARD CAP, PHILIP**

621301	tie-band	green/white	one-size	100/500
--------	----------	-------------	----------	---------



**STANDARD CAP, PEGGY**

621600	elastic	blue	one-size	100/500
621700	elastic	green	one-size	100/500



**SPECIAL CAP, GLENN**

620200	elastic, tie-band, sweat band	green	one-size	40/200
--------	-------------------------------	-------	----------	--------



**SPECIAL CAP, ALBIN**

620250 elastic, tie-band, sweat band green one-size 60/300

**SPECIAL CAP, GALEUS**

622000 elastic blue/green one-size 100/500

**SPECIAL CAP, COMMODUS**

622010 elastic, sweat band blue/green/white one-size 60/300

**SPECIAL CAP, PARVUS**

622030 elastic blue/green one-size 100/500



STANDARD CAP, FASHION

4210 elastic flower pattern one-size 100/300



STANDARD CAP, FASHION BONNET

4212 tie-band flower pattern one-size 50/300



STANDARD CAP

4215 elastic green one-size 50/300



STANDARD CAP, SHEER BOUFFANT

4220 elastic blue green regular 100/600  
 4221 elastic green regular 100/600  
 4222 elastic blue large 100/600  
 4223 elastic green large 100/600



**STANDARD CAP, SURGICAL**

4240 tie-band blue one-size 100/600

**STANDARD CAP, SURGICAL**

4241 tie-band blue one-size 100/300

**STANDARD CAP, SURGICAL HOOD**

4242 tailored fit blue one-size 50/200

**STANDARD CAP, SURGICAL**

4245 tie-band blue one-size 100/600



**STANDARD CAP, BOUFFANT**

42610	elastic	white	one-size	100/600
42620	elastic	blue	one-size	100/600
42630	elastic	green	one-size	100/600
42640	elastic	pink	one-size	100/600



**STANDARD CAP, SURGEONS HOOD**

7000002	tailored fit	blue	one-size	40/160
---------	--------------	------	----------	--------



**EXTRA COMFORT CAP, MICKI**

42007	tie-band	green	one-size	25/150
-------	----------	-------	----------	--------



**EXTRA COMFORT CAP, FLOTT**

42013	Bouffant Cap	green	one-size	100/600
70042013	Bouffant Cap, latex free elastic	green	one-size	100/600





**EXTRA COMFORT CAP, KIDS**

42014                      elastic                                      green                      one-size                      100/600



**EXTRA COMFORT CAP, MISS**

42021                      elastic                                      white                      one-size                      100/600  
 42022                      elastic                                      blue                      one-size                      100/600  
 42023                      elastic                                      green                      one-size                      100/600  
 42024                      elastic                                      yellow                      one-size                      100/600  
 42025                      elastic                                      pink                      one-size                      100/600



**EXTRA COMFORT CAP, CHIC**

42031                      tie-band                                      white                      one-size                      100/600  
 42033                      tie-band                                      blue                      one-size                      100/600  
 42034                      tie-band                                      green                      one-size                      100/600  
 42035                      tie-band                                      yellow                      one-size                      100/600  
 42036                      tie-band                                      pink                      one-size                      100/600



**EXTRA COMFORT CAP, THEATRE**

42042                      tie-band                                      blue                      one-size                      100/600  
 42044                      tie-band                                      green                      one-size                      100/60



**EXTRA COMFORT CAP, ELAST**

42061	tailored fit	white	one-size	100/600
42062	tailored fit	blue	one-size	100/600
42063	tailored fit	green	one-size	100/600



**EXTRA COMFORT CAP, SURGEONS HOOD ALL LADY**

42071	tie-band	green	one-size	100/600
-------	----------	-------	----------	---------



**EXTRA COMFORT CAP, SURGEONS HOOD ALL**

42072	tie-band	blue	one-size	100/600
42073	tie-band	green	one-size	100/600



**EXTRA COMFORT CAP, SURGEONS HOOD ALL PRO**

42074	tie-band, sweatband	green	one-size	50/300
42076	tie-band, sweatband, collar	green	one-size	40/240



**EXTRA COMFORT CAP, TOP NURSE**

42093	elastic	green	one-size	100/600
42094	elastic	blue	one-size	100/600



**EXTRA COMFORT CAP, FLAIR BOUFFANT**

42112	elastic	blue	one-size	75/450
42113	elastic	green	one-size	75/450



## THE QUALITY IS IN THE DETAIL

The skin area around the mouth and nose is one of the most sensitive parts of the human body. In a healthcare setting, where facemasks are used for many hours on a daily basis, comfort is key to product acceptance.

BARRIER facemasks are made from highest quality materials. They offer the best possible filter efficiency, the lowest breathing resistance and optimize cup shape. Maintaining a proper cup shape is important for keeping the mask away from the user's lips during use to minimize contact between mouth and facemask. This will prevent possible fluid strike through and the subsequent transmission of microorganisms from inside to outside.

STANDARD FACE MASK

657000	tie-band	blue	50/300*
657060	tie-band	green	50/300*
657070	tie-band	white	50/300*
657100	tie-band, extra wide	blue	50/300*
657160	tie-band, extra wide	green	50/300*
657170	tie-band, extra wide	white	50/300*
657010	tie-band, anti-fog	blue	50/300*



STANDARD FACE MASK

657020	tie-band, anti-fog, anti-reflection	blue	50/300*
--------	--	------	---------



STANDARD FACE MASK

657030	tie-band, anti-fog, anti-reflection, visor	blue	50/300*
--------	---	------	---------



STANDARD FACE MASK

657200	ear-loop	blue	50/600*
657260	ear-loop	green	50/600*
657270	ear-loop	white	50/600*



**STANDARD FACE MASK****657230**ear-loop, anti-fog,  
anti-reflection, visor

blue

50/300\*

**SPECIAL FACE MASK****658000**

tie-band

green

50/300\*

**658010**

tie-band, anti-fog

green

50/300\*

**SPECIAL FACE MASK****658020**tie-band, anti-fog,  
anti-reflection

green

50/300\*

**SPECIAL FACE MASK****658030**tie-band, anti-fog,  
anti-reflection, visor

green

50/300\*



---

**SPECIAL FACE MASK**

658200

ear-loop

green

50/300\*



---

**SPECIAL FACE MASK**

658300

tie-band, "soft"

white

50/300\*



**BASIC FACE MASK**

4301	ear-loop	green	50/600
4311	ear-loop	blue	50/600
4331	ear-loop	green	50/600
4332	ear-loop	pink	50/600
4333	ear-loop	white	50/600
4334	ear-loop	blue	50/600



**BASIC FACE MASK**

4302	tie-band	green	50/600
4312	tie-band	blue	50/600
4330	tie-band	blue	50/600



**BASIC FACE MASK**

4235	elastic band	blue	50/600
------	--------------	------	--------



**STANDARD FACE MASK**

4280	tie-band, soft	blue	60/360
42280	tie-band	blue	60/360
42290	tie-band	green	60/360





STANDARD FACE MASK

42270	ear-loop	blue	50/300
412801	ear-loop	white	50/1000



STANDARD FACE MASK

291210	ear-loop	pink	50/600
291220	ear-loop	blue	50/600
291230	ear-loop	white	50/600



EXTRA COMFORT STANDARD FILTRATION FACE MASK

4225	ear-loop, anti-fog, anti-reflection, splash-resistant	blue	50/300
------	---	------	--------



EXTRA COMFORT STANDARD FILTRATION FACE MASK

4228	ear-loop	blue	50/300
4229	ear-loop, anti-fog, anti-reflection	blue	50/300



## EXTRA COMFORT STANDARD FILTRATION FACE MASK

4230	tie-band, hypoallergenic innerfacing	blue	50/300
4231	tie-band, foam anti-fog, anti-reflection, hypoallergenic innerfacing	blue	50/300



## EXTRA COMFORT STANDARD FILTRATION FACE MASK

4233	tie-band, duck-bill hypoallergenic	blue	50/300
------	---------------------------------------	------	--------



## EXTRA COMFORT STANDARD FILTRATION FACE MASK

4237	tie-band	floral	50/300
4239	tie-band	green	50/300
4238	tie-band, anti-fog, anti-reflection	green	50/300



## EXTRA COMFORT STANDARD FILTRATION FACE MASK

4229	ear-loop, anti-fog, anti-reflection	blue	50/300
------	--	------	--------



**EXTRA COMFORT HIGH FILTRATION FACE MASK**

**4224** ear-loop, anti-fog, blue 50/300  
 anti-reflection,  
 splash-resistant,  
 hypoallergenic innerfacing



**EXTRA COMFORT HIGH FILTRATION FACE MASK**

**4232** tie-band, anti-fog, blue 25/100  
 anti-reflection, visor,  
 splash-resistant



**EXTRA COMFORT HIGH FILTRATION FACE MASK**

**4234** tie-band, anti-fog, blue 50/300  
 anti-reflection,  
 splash-resistant,  
 hypoallergenic innerfacing

**4236** tie-band, anti-fog, lavender 50/300  
 anti-reflection,  
 splash-resistant



**EXTRA COMFORT HIGH FILTRATION FACE MASK**

**4267** ear-loop, anti-fog, blue 25/100  
 anti-reflection, visor,  
 splash-resistant



**EXTRA COMFORT HIGH FILTRATION FACE MASK**

<b>428801</b>	tie-band, anti-fog, short nose clip	green	50/300
<b>428901</b>	tie-band, short nose clip	green	50/300

**EXTRA FILTRATION EN149:2001 FACE MASK**

<b>42902</b>	elastic band - yellow, meet requirements of EN149:2001 FFP1	white	20/200
<b>42904</b>	elastic band - blue, meet requirements of EN149:2001 FFP2	white	20/200

**N95 RESPIRATOR/SURGICAL MASK**

<b>4270</b>	elastic band	white	20/120
<b>4271</b>	elastic band	white	20/120



## YOU CAN NEVER BE TOO SECURE

BARRIER provides a supplementary range of protective clothing for the safety and comfort of hospital staff, patients and visitors.

Protective clothing like glasses, aprons and isolation gowns provide extra protection to the hospital staff. Patient clothing provides comfort and integrity to the patient in a sometimes stressful environment.

Finally, BARRIER enables visitors to meet with the patient before and after surgery in a controlled way.

**MINOR PROCEDURE GOWN**

614400

non-sterile, bulk

L

/80

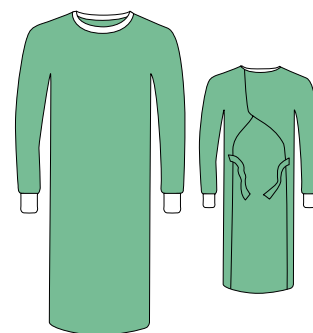
**PATIENT SHIRT**

614550

sleeveless

blue

one-size

10/140

**PATIENT SHIRT**

616560

short sleeve

blue

one-size

10/140

**PROTECTIVE APRON**

613000

2-ply laminate 115 x 75 cm white

/200



---

**PROTECTIVE APRON**

613100

2-ply laminate 145 x 75 cm white

/150



---

**PROTECTIVE APRON**

613350

plastic 140 x 81 cm white

100/500



## SHOE COVER

**359000**  
**21101**plastic 36 x 15 cm  
plastic 41x16,5 cmblue  
green100/1000  
/1000

## SHOE COVER

**359010**nonwoven 35 g/m<sup>2</sup>  
37 x 16,5 cm

white

/400



## SHOE COVER

**359020**nonwoven 40 g/m<sup>2</sup>  
37 x 16,5 cm

white

/400



## SHOE COVER

**359030**nonwoven 40 g/m<sup>2</sup>  
37 x 19,5 cm

blue

/400

**414201**nowoven 44g/m<sup>2</sup>  
40x18 cm

blue

one-size

/1000





---

**SHOE COVER**

<b>359050</b>	nonwoven 35 g/m <sup>2</sup> / plastic 37 x 16,5 cm	white/blue	/400
<b>359070</b>	nonwoven 35 g/m <sup>2</sup> / plastic 39,5 x 16,5 cm	white/blue	/400



**ISOLATION GOWN**

1901	yellow	L	/50
1902	blue	L	/50
1903	green	L	/50
1904	white	L	/50
1905	dark blue	L	/50
1921	yellow	XL	/50
1922	blue	XL	/50
1923	green	XL	/50
1924	white	XL	/50
1925	dark blue	XL	/50



**IMPERVIOUS ISOLATION GOWN**

1931	yellow	L	/50
1932	blue	L	/50
1933	yellow	XL	/40
1934	blue	XL	/40



**STERILE ISOLATION GOWN**

616641	one towel	dark blue	L	28/56
616650		dark blue	L	26/52



**VISITOR'S APPAREL KIT**

1810	scrub suit, face mask, head wear and shoe cover	blue	one-size	/30
1809	isolation gown, face mask, head wear and shoe cover	blue	one-size	/30



---

**EYE GOGGLES**

1701 elastic strap one-size /30



---

**PROTECTIVE GLASSES**

1702 one-size 10/30



---

**SINGLE-USE NONWOVEN BLANKET**

629999 nonwoven, 130x190 cm white /20



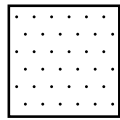

Standard Nonwoven Abdominal Swab

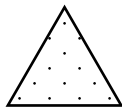

Standard Nonwoven Surgical Swab

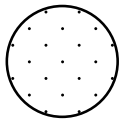

Standard Nonwoven Surgical Sponge

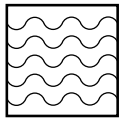

Special Nonwoven Abdominal Swab

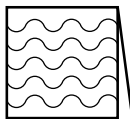

Special Nonwoven Abdominal Swab With Loop

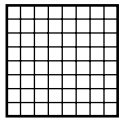

Standard Gauze Abdominal Swab

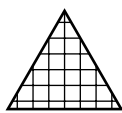

Standard Gauze Surgical Swab

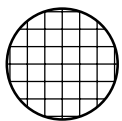

Standard Gauze Surgical Sponge

## **XRD DO NOT COMPROMISE IN SECURITY**

Our complete X-ray detectable assortment, made of nonwoven or cotton gauze, has a unique patented wrapping inner packaging and a control system that enables a safe handling for the surgical team.

BARRIER XRD products are developed and designed with patient safety in focus.

STANDARD NONWOVEN ABDOMINAL SWABS, 70g

185060	sterile, 5-pcs	10x40 cm	white	125/750
185260	sterile, 5-pcs	20x40 cm	white	65/390
185440	sterile, 2-pcs	30x40 cm	white	40/240
185460	sterile, 5-pcs	30x40 cm	white	45/270
185660	sterile, 5-pcs	40x40 cm	white	60/360
185830	sterile, 1-pcs	40x65 cm	white	30/180
185860	sterile, 5-pcs	40x65 cm	white	30/180

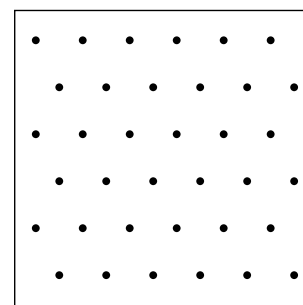

STANDARD NONWOVEN SURGICAL SWABS, 70g

185105	sterile, 5-pcs	7.5x7.5 cm, 6-ply	white	100/600
185110	sterile, 10-pcs	7.5x7.5 cm, 6-ply	white	110/660
185305	sterile, 5-pcs	10x10 cm, 6-ply	white	90/540
185310	sterile, 10-pcs	10x10 cm, 6-ply	white	90/540
185405	sterile, 5-pcs	10x10 cm, 6-ply	white	90/540
185410	sterile, 10-pcs	10x10 cm, 6-ply	white	90/540
185100	non-sterile, bulk	7.5x7.5 cm, 6-ply	white	100/2000
185100	non-sterile, bulk	10x10 cm, 6-ply	white	100/1400
185100	non-sterile, bulk	10x20 cm, 6-ply	white	50/700

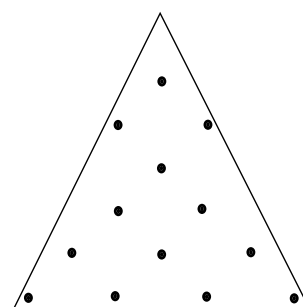

STANDARD NONWOVEN SURGICAL SPONGES, 40g

154160	sterile, 5-pcs	No 1	white	175/1050
154360	sterile, 5-pcs	No 3	white	150/900
154460	sterile, 5-pcs	No 4	white	75/450
154560	sterile, 5-pcs	No 5	white	75/450
154100	non-sterile, bulk	No 1	white	1000/3000
154300	non-sterile, bulk	No 3	white	250/3500
154400	non-sterile, bulk	No 4	white	100/1200
154500	non-sterile, bulk	No 5	white	100/800

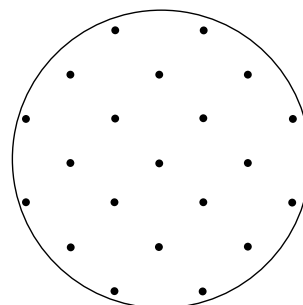

**SPECIAL NONWOVEN ABDOMINAL SWABS, 130g**

<b>187602</b>	sterile, 2-pcs	10x60 cm	white	40/240
<b>187605</b>	sterile, 5-pcs	10x60 cm	white	40/240
<b>187702</b>	sterile, 2-pcs	30x30 cm	white	30/180
<b>187705</b>	sterile, 5-pcs	30x30 cm	white	30/180
<b>187802</b>	sterile, 2-pcs	40x40 cm	white	24/144
<b>187805</b>	sterile, 5-pcs	40x40 cm	white	25/150
<b>187901</b>	sterile, 1-pcs	40x60 cm	white	14/84
<b>187902</b>	sterile, 2-pcs	40x60 cm	white	16/96
187600	non-sterile, bulk	10x60 cm	white	45/360
187700	non-sterile, bulk	30x30 cm	white	35/280
187800	non-sterile, bulk	40x40 cm	white	35/280
187900	non-sterile, bulk	40x60 cm	white	20/160

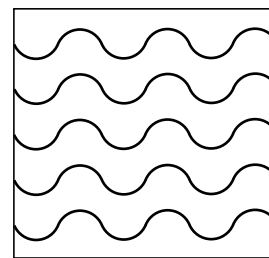

**SPECIAL NONWOVEN ABDOMINAL SWABS, 130g**

<b>187722</b>	sterile, 2-pcs	30x30 cm	green	30/180
<b>187725</b>	sterile, 5-pcs	30x30 cm	green	30/180
<b>187822</b>	sterile, 2-pcs	40x40 cm	green	24/144
<b>187922</b>	sterile, 2-pcs	40x60 cm	green	16/96
187720	non-sterile, bulk	30x30 cm	green	35/280
187820	non-sterile, bulk	40x40 cm	green	35/280
187920	non-sterile, bulk	40x60 cm	green	20/160

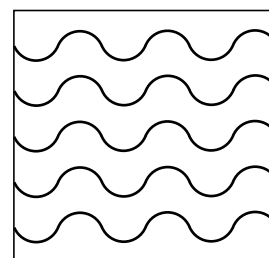

**SPECIAL NONWOVEN ABDOMINAL SWABS, 130g**

<b>187712</b>	sterile, 2-pcs	30x30 cm	white	30/180
<b>187812</b>	sterile, 2-pcs	40x40 cm	white	24/144
<b>187815</b>	sterile, 5-pcs	40x40 cm	white	25/150
<b>187912</b>	sterile, 2-pcs	40x60 cm	white	16/96
187720	non-sterile, bulk	30x30 cm	white	35/280
187820	non-sterile, bulk	40x40 cm	white	35/280
187920	non-sterile, bulk	40x60 cm	white	20/160

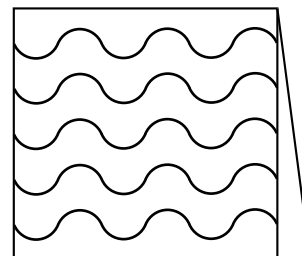

**SPECIAL NONWOVEN ABDOMINAL SWABS WITH LOOP, 130g**

<b>187832</b>	sterile, 2-pcs	40x40 cm	green	24/144
<b>187835</b>	sterile, 2-pcs	40x40 cm	green	25/150
<b>187932</b>	sterile, 5-pcs	40x60 cm	green	16/96
187730	non-sterile, bulk	30x30 cm	green	35/280
187830	non-sterile, bulk	40x40 cm	green	35/280
187930	non-sterile, bulk	40x60 cm	green	20/160

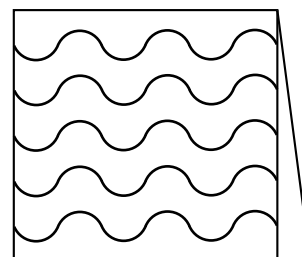

STANDARD GAUZE ABDOMINAL SWABS

<b>175131</b>	sterile, 1-pcs	45x70 cm, 3-ply	white	22/132
<b>175160</b>	sterile, 5-pcs	45x70 cm, 3-ply	white	25/150
<b>175260</b>	sterile, 5-pcs	30x45 cm, 3-ply	white	55/330
<b>175360</b>	sterile, 5-pcs	40x45 cm, 3-ply	white	45/270
175100	non-sterile, bulk	45x70 cm, 3-ply	white	100/300
175200	non-sterile, bulk	30x45 cm, 3-ply	white	100/500

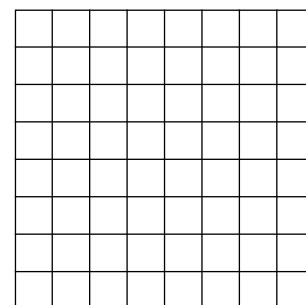

STANDARD GAUZE SURGICAL SWABS

<b>159160</b>	sterile, 5-pcs	10x10 cm, 12-ply	white	130/780
<b>159175</b>	sterile, 10-pcs	10x10 cm, 12-ply	white	130/780
<b>159460</b>	sterile, 5-pcs	10x60 cm, 4-ply	white	125/750
<b>159475</b>	sterile, 10-pcs	10x60 cm, 4-ply	white	110/660
<b>159660</b>	sterile, 5-pcs	10x60 cm, 8-ply	white	65/390
<b>159675</b>	sterile, 10-pcs	10x60 cm, 8-ply	white	70/420
<b>159860</b>	sterile, 5-pcs	10x60 cm, 12-ply	white	55/330
159100	non-sterile, bulk	10x10 cm, 12-ply	white	175/3500
159400	non-sterile, bulk	10x60 cm, 4-ply	white	150/1500
159600	non-sterile, bulk	10x60 cm, 8-ply	white	75/750

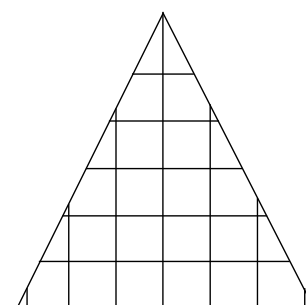

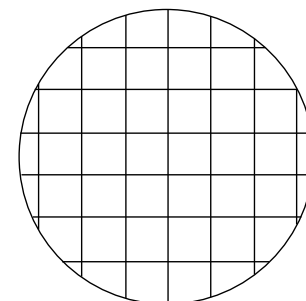

STANDARD GAUZE SURGICAL SPONGES

<b>150060</b>	sterile, 5-pcs	No 0	white	200/1200
<b>150160</b>	sterile, 5-pcs	No 1	white	175/1050
<b>150360</b>	sterile, 5-pcs	No 3	white	150/900
<b>150460</b>	sterile, 5-pcs	No 4	white	100/600
<b>150560</b>	sterile, 5-pcs	No 5	white	100/600
150000	non-sterile, bulk	No 0	white	1000/5000
150100	non-sterile, bulk	No 1	white	250/2500
150300	non-sterile, bulk	No 3	white	250/4000
150400	non-sterile, bulk	No 4	white	250/3000
150500	non-sterile, bulk	No 5	white	100/1200





 Standard Nonwoven  
Super Nonwoven  
Ultra Nonwoven

 Standard Nonwoven  
Super Nonwoven  
Ultra Nonwoven

 Standard/Standard Nonwoven  
Super/Super Nonwoven  
Super/Standard Nonwoven  
Ultra/Super Nonwoven

## TRAY WRAPS FOR PEACE OF MIND

BARRIER offer an extensive range of tray wraps, that provides an effective barrier to bacteria and fluids, suited for different types of trays. The strong nonwoven materials are gentle to the skin and memory free even after sterilisation.

STANDARD/STANDARD

90909	75 x 75	blue/green Interleaved	/250
90903	90 x 90	blue/green Interleaved	/250
91003	100 x 100	blue/green Interleaved	/200
91201	100 x 120	blue/green Interleaved	/100
80007000	120 x 120	blue/green Interleaved	/100
91373	137 x 137	blue/green Interleaved	/100
80601301	130 x 150	blue/green Interleaved	/100
91376	137 x 150	blue/green Interleaved	/100
91403	140 x 100	blue/green Interleaved	/100
915031	150 x 188	blue/green Interleaved	/50

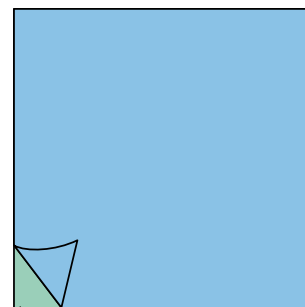

STANDARD

906011	60 x 60	green	/500
90908	75 x 75	green	/250
90901	90 x 90	green	/250
91001	100 x 100	green	/200
91371	137 x 137	green	/100
91301	130 x 150	green	/250

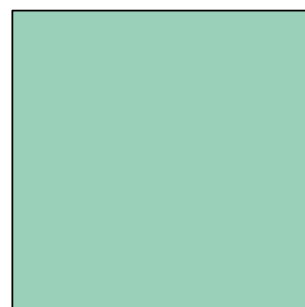

STANDARD

90906	60 x 60	blue	/500
90907	75 x 75	blue	/250
90902	90 x 90	blue	/250
91002	100 x 100	blue	/200
80600120	120 x 120	blue	/100
91372	137 x 137	blue	/100

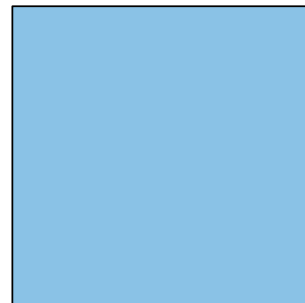

**SUPER/SUPER**

<b>80903</b>	90 x 90	blue/green Interleaved	/250
<b>81003</b>	100 x 100	blue/green Interleaved	/200
<b>81201</b>	100 x 120	blue/green Interleaved	/100
<b>81273</b>	127 x 90	blue/green Interleaved	/150
<b>81373</b>	137 x 137	blue/green Interleaved	/100
<b>81376</b>	137 x 150	blue/green Interleaved	/100
<b>815031</b>	150 x 188	blue/green Interleaved	/50

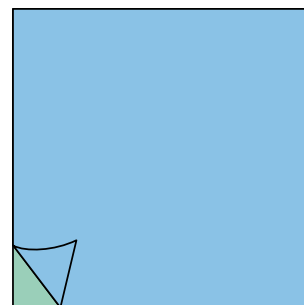

**SUPER**

<b>81001</b>	100 x 100	green	/200
<b>81371</b>	137 x 137	green	/100
<b>815011</b>	150 x 188	green	/50

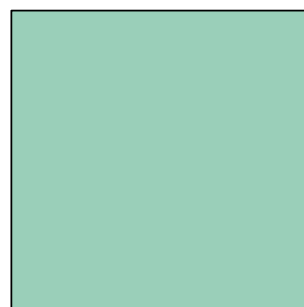

**SUPER**

<b>80902</b>	90 x 90	blue	/250
<b>81002</b>	100 x 100	blue	/200
<b>81372</b>	137 x 137	blue	/100
<b>81502</b>	150 x 188	blue	/50

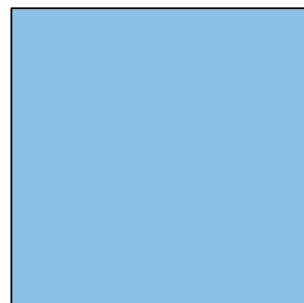

**SUPER/STANDARD**

<b>71003</b>	100 x 100	blue (super)/green (standard) interleaved	/200
<b>71373</b>	137 x 137	blue (super)/green (standard) interleaved	/100
<b>71503</b>	150 x 188	blue (super)/green (standard) interleaved	/50

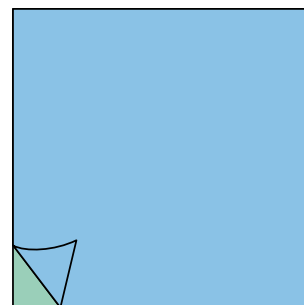

**ULTRA/SUPER**

<b>61373</b>	137 x 137	blue (ultra)/green (super) interleaved	/100
<b>61503</b>	150 x 188	blue (ultra)/green (super) interleaved	/50

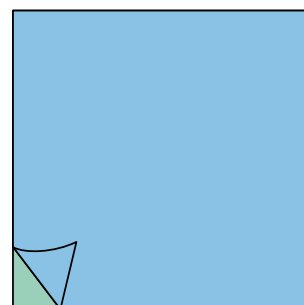



MÖLNLYCKE  
HEALTH CARE



**BARRIER®**

NO COMPROMISE IN SECURITY